

**PRINTING INSTRUCTIONS**

We recommend printing at full-scale to check the fit with your tools before ordering.

**Option 1:** Print this page full-scale on a large-format printer (E-Size, 44 inches X 34 inches).

**Option 2:** Print page 2 - 10 on 8-1/2 X 11 inch paper and assemble.

**Thank You!**

THE INFORMATION CONTAINED ON THIS DRAWING IS THE SOLE PROPERTY OF FOAMFIT TOOLS AND MAY NOT BE USED WITHOUT PERMISSION. Copyright 2023 FoamFit Tools

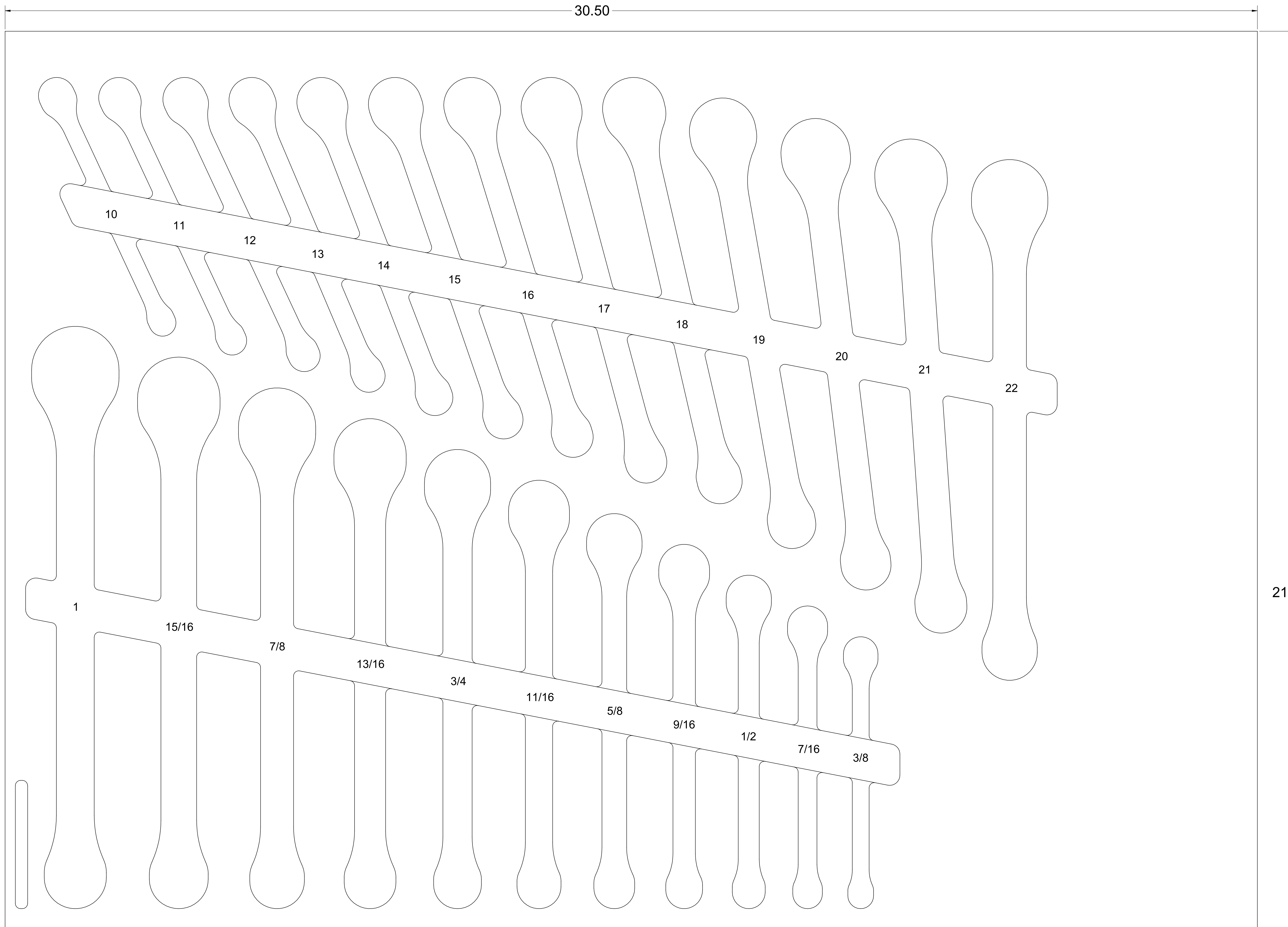
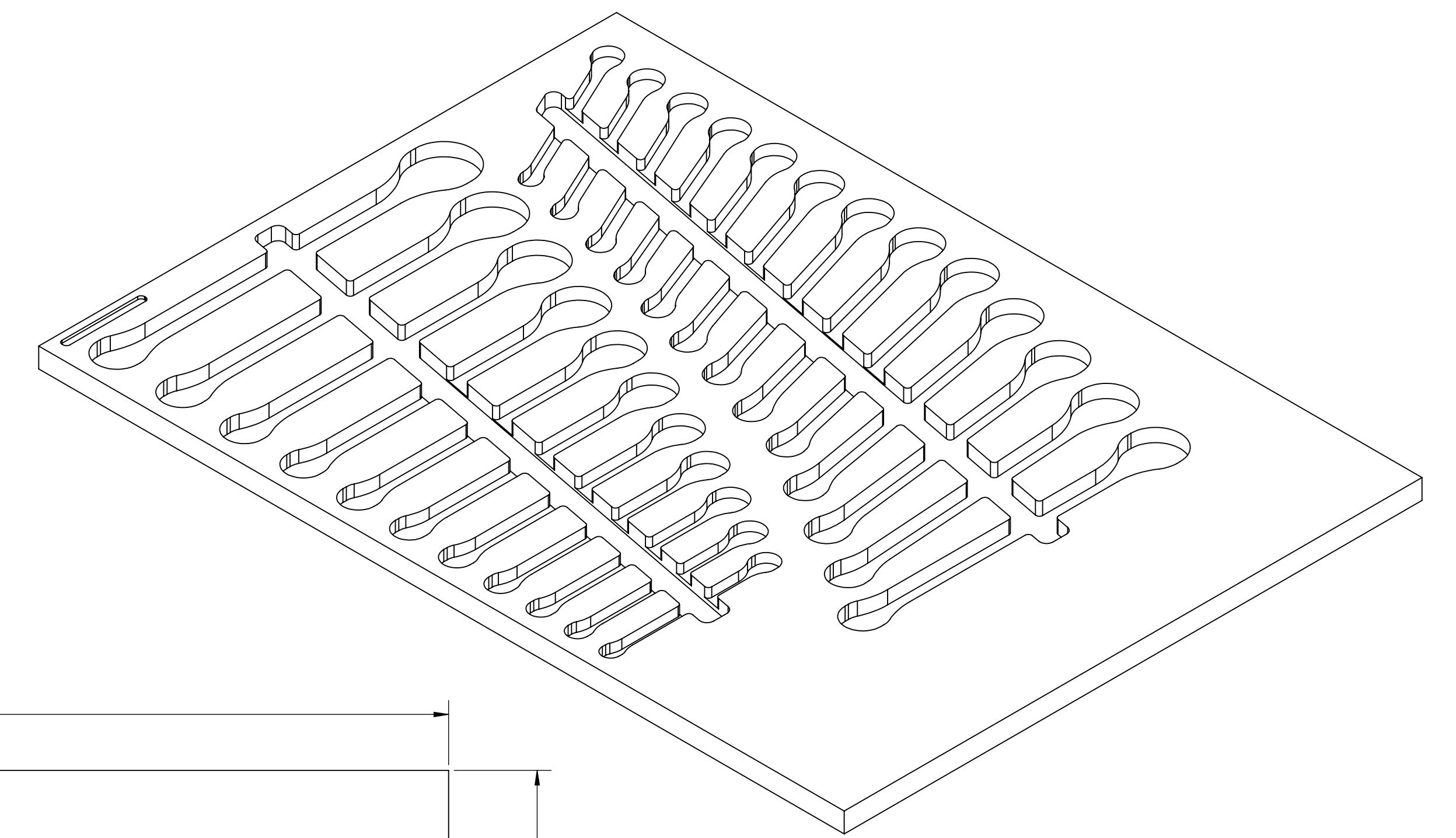

PART NUMBER **F-05457-R**

Print on Letter at 100%

1.00  
IN

1.00 IN

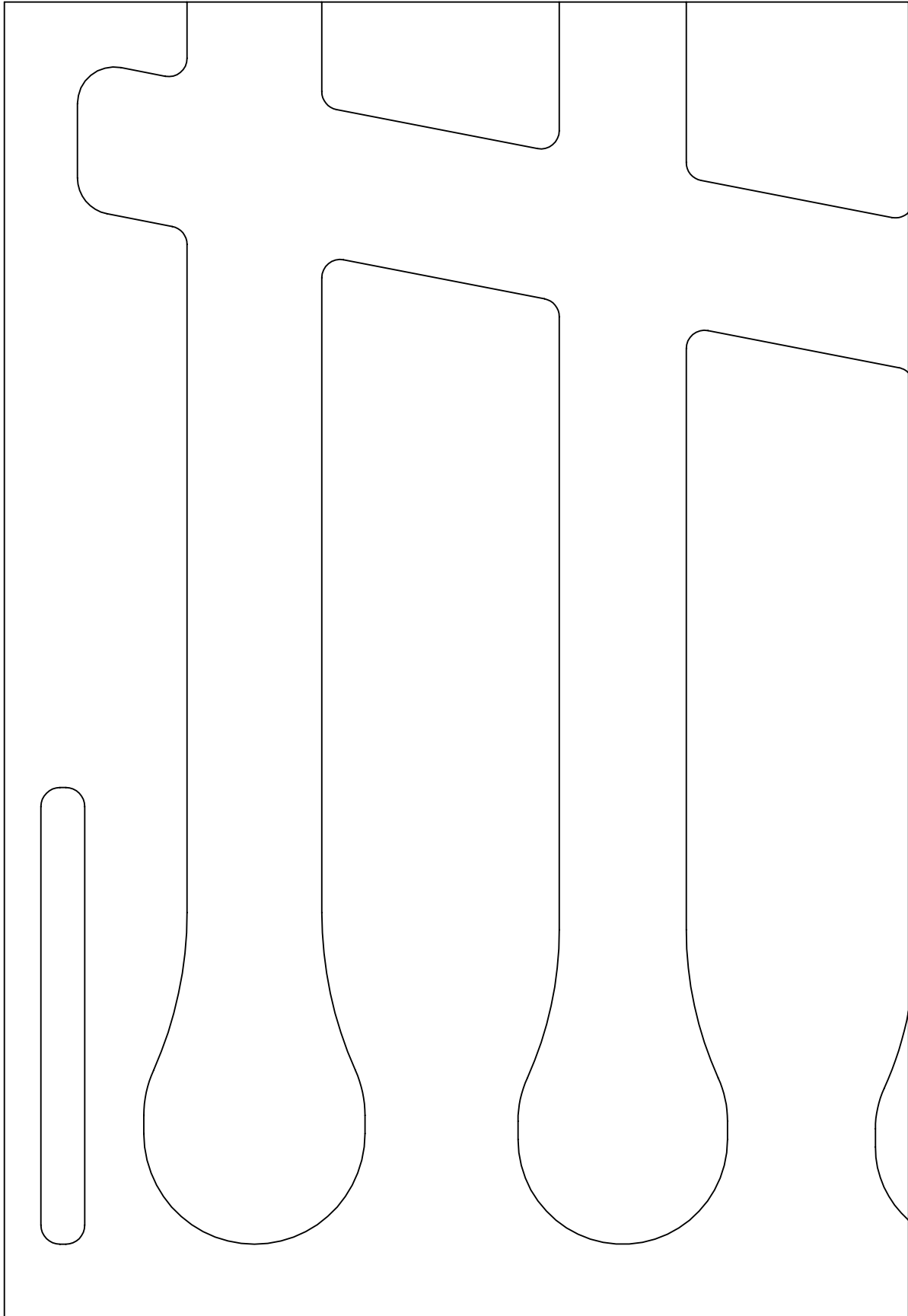

PAGE KEY

|   |  |  |  |  |  |  |  |  |  |
|---|--|--|--|--|--|--|--|--|--|
| X |  |  |  |  |  |  |  |  |  |
|---|--|--|--|--|--|--|--|--|--|

DATE CREATED

**04 DEC 2023**

PART NUMBER

**F-05457-R**





1.00 IN

PAGE KEY

|   |  |  |  |  |  |  |  |  |  |
|---|--|--|--|--|--|--|--|--|--|
| X |  |  |  |  |  |  |  |  |  |
|---|--|--|--|--|--|--|--|--|--|

1.00  
IN

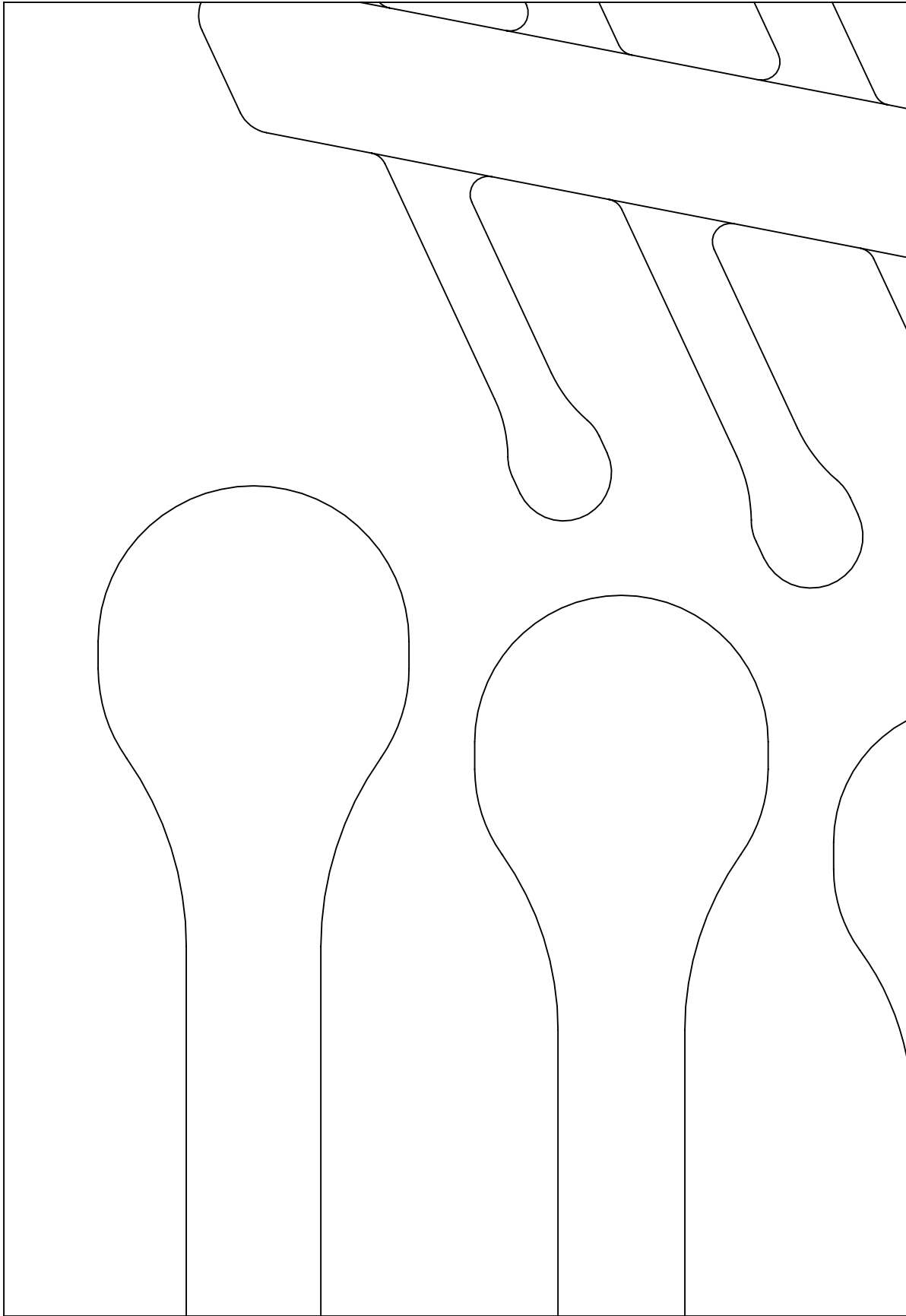

Print on Letter at 100%

DATE CREATED

**04 DEC 2023**

PART NUMBER

**F-05457-R**

1.00 IN

PAGE KEY

|   |  |  |  |  |  |  |  |  |  |
|---|--|--|--|--|--|--|--|--|--|
| X |  |  |  |  |  |  |  |  |  |
|---|--|--|--|--|--|--|--|--|--|

1.00  
IN

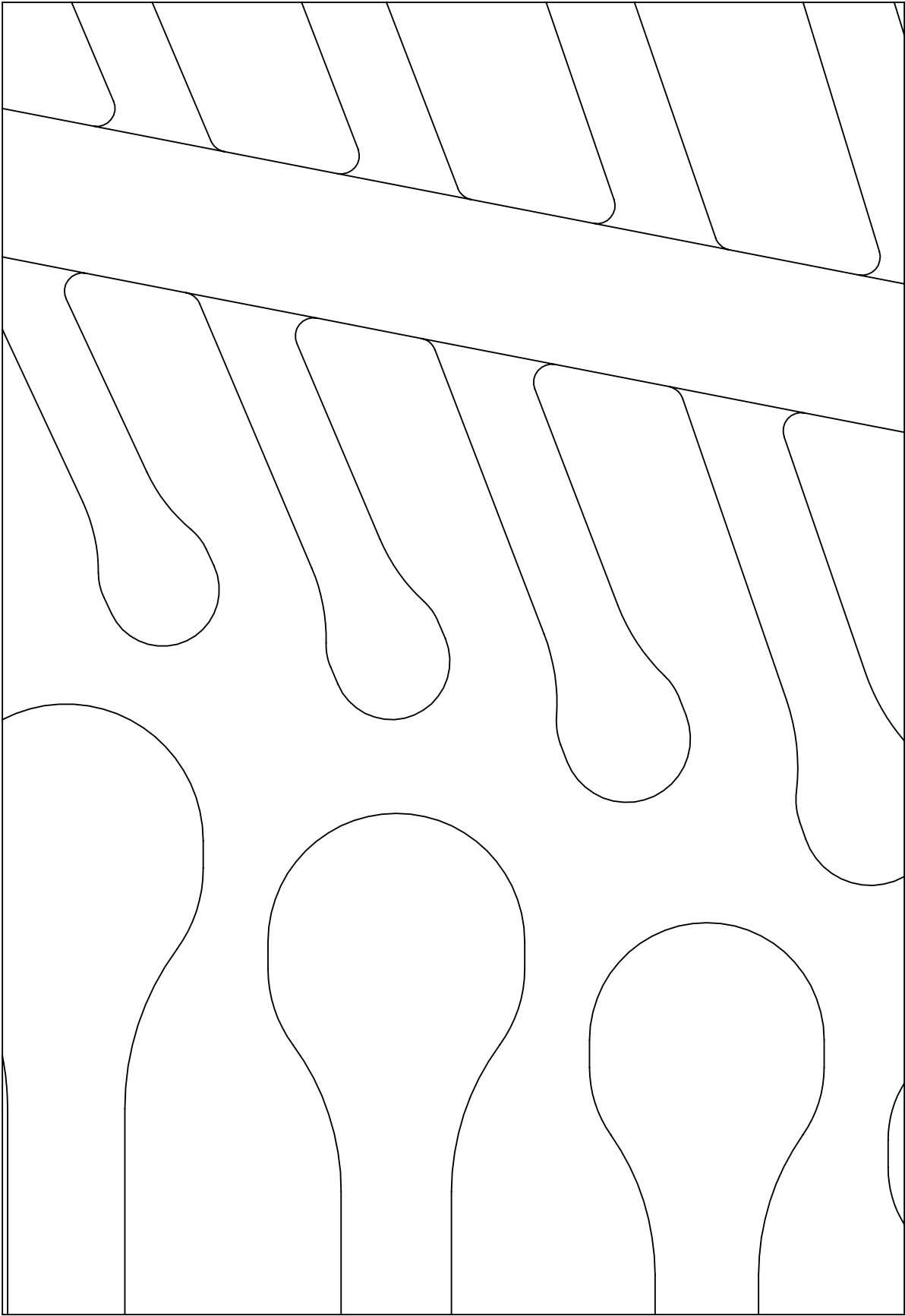

Print on Letter at 100%

DATE CREATED

**04 DEC 2023**

PART NUMBER

**F-05457-R**

1.00 IN

PAGE KEY

|  |  |  |  |  |   |
|--|--|--|--|--|---|
|  |  |  |  |  |   |
|  |  |  |  |  | X |

1.00 IN

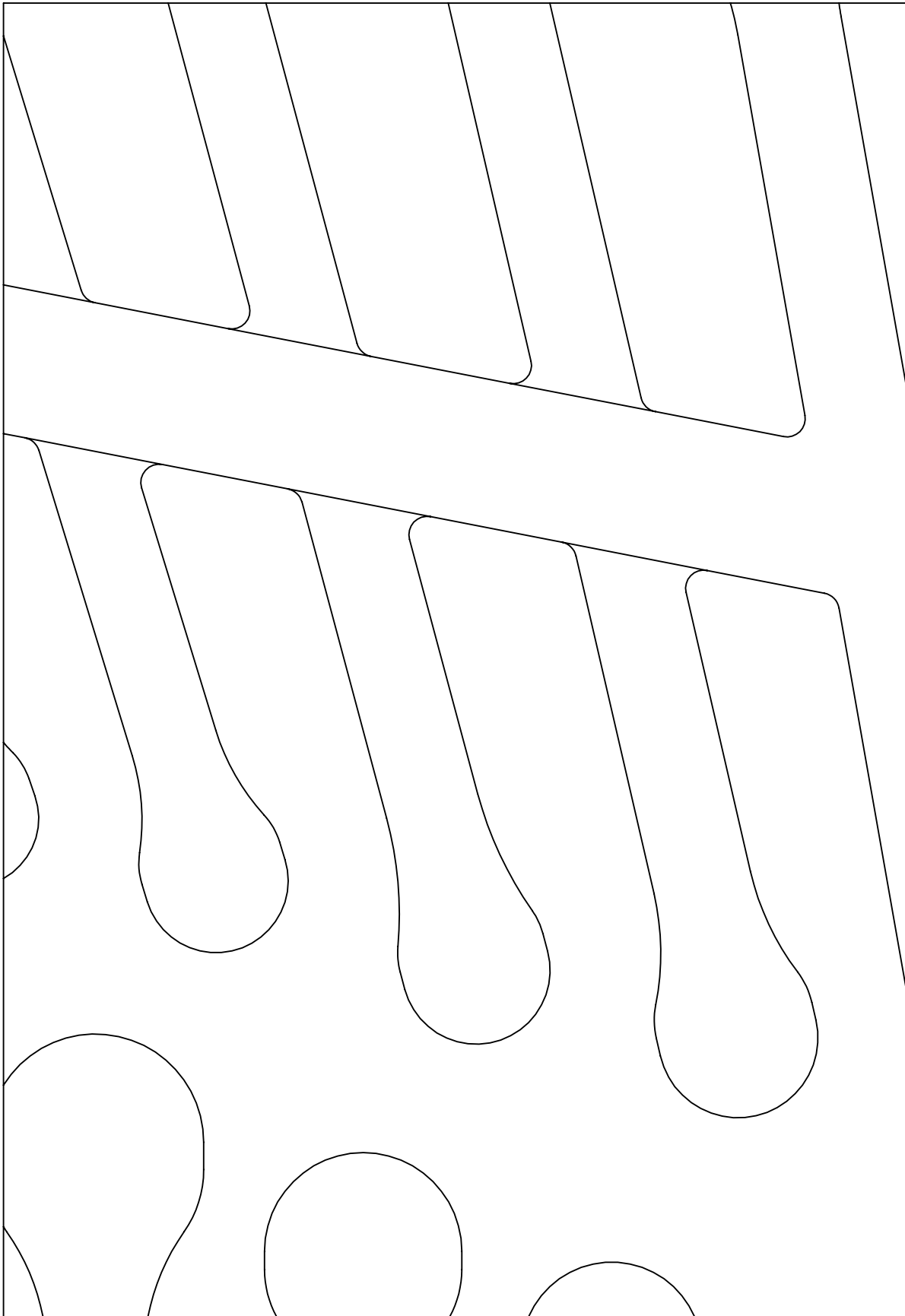

Print on Letter at 100%

DATE CREATED

**04 DEC 2023**

PART NUMBER

**F-05457-R**

1.00 IN

PAGE KEY

|   |  |  |  |  |  |  |  |  |  |
|---|--|--|--|--|--|--|--|--|--|
| X |  |  |  |  |  |  |  |  |  |
|   |  |  |  |  |  |  |  |  |  |
|   |  |  |  |  |  |  |  |  |  |
|   |  |  |  |  |  |  |  |  |  |

1.00  
IN

DATE CREATED  
**04 DEC 2023**

PART NUMBER  
**F-05457-R**

Print on Letter at 100%

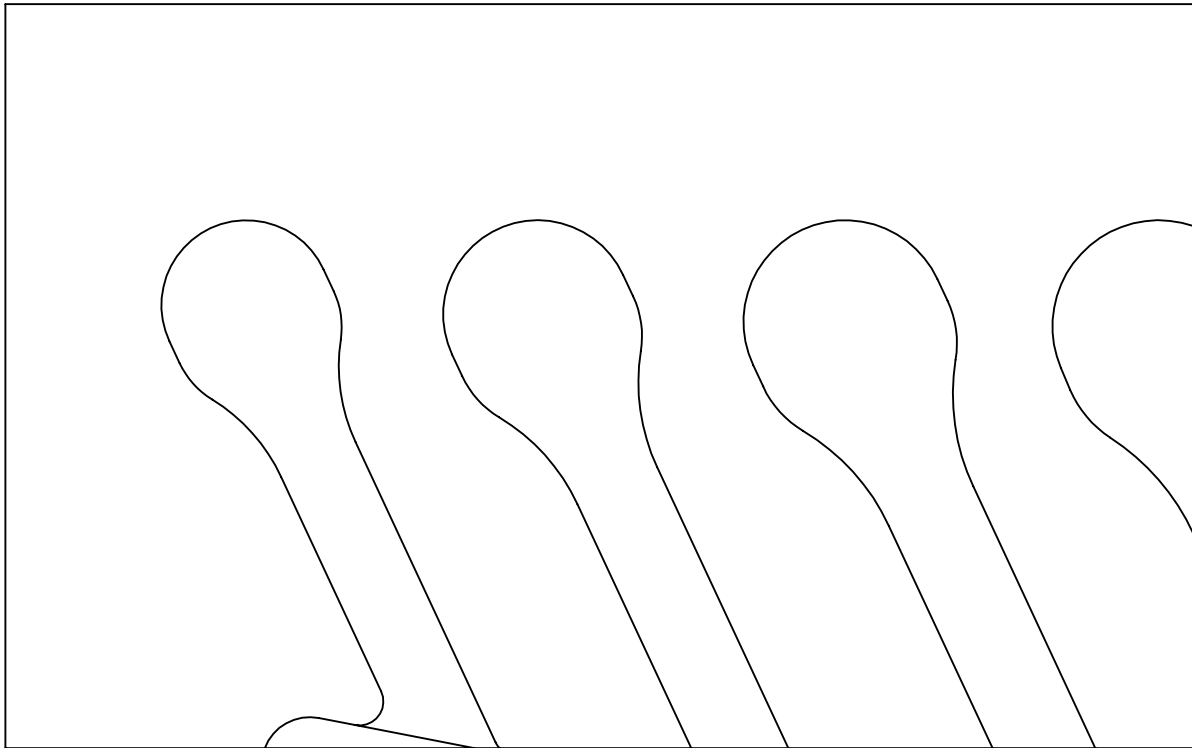



1.00 IN

PAGE KEY

|   |  |  |  |  |  |  |  |  |  |
|---|--|--|--|--|--|--|--|--|--|
| X |  |  |  |  |  |  |  |  |  |
|   |  |  |  |  |  |  |  |  |  |
|   |  |  |  |  |  |  |  |  |  |
|   |  |  |  |  |  |  |  |  |  |

1.00  
IN

DATE CREATED  
**04 DEC 2023**

PART NUMBER  
**F-05457-R**

Print on Letter at 100%

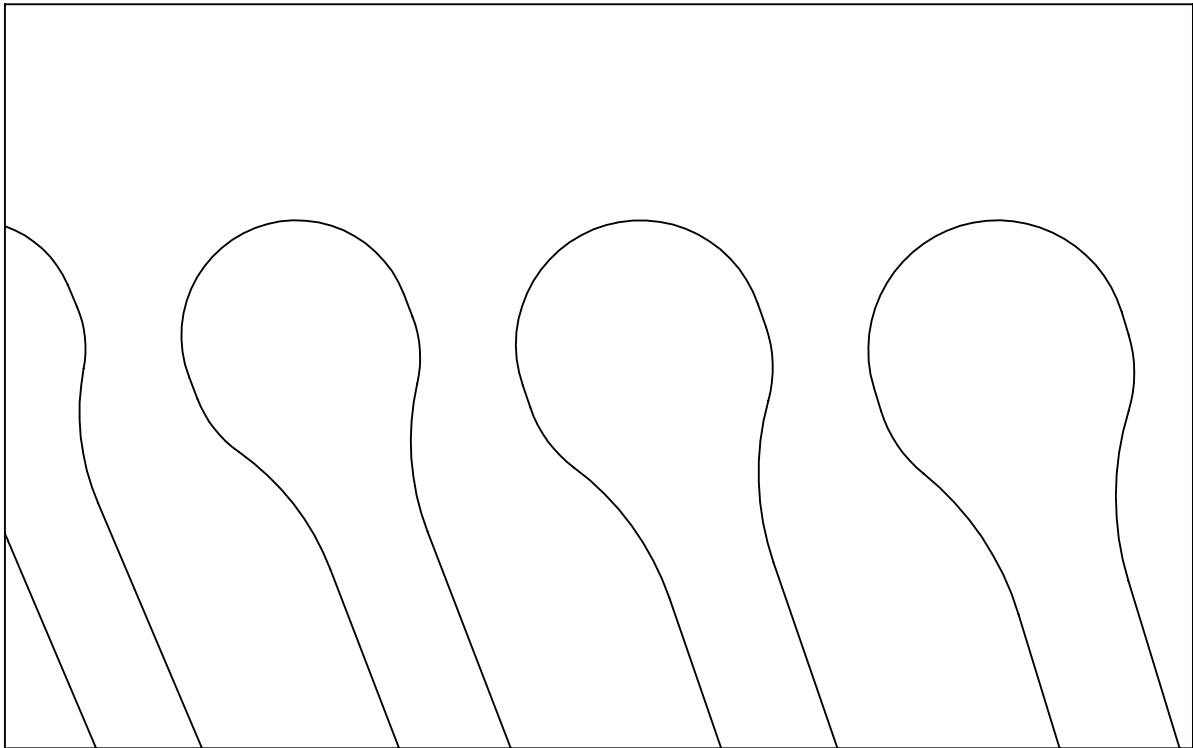

1.00 IN

PAGE KEY

|   |
|---|
| X |
|   |
|   |
|   |

1.00  
IN

DATE CREATED  
**04 DEC 2023**

PART NUMBER  
**F-05457-R**

Print on Letter at 100%

