

PRINTING INSTRUCTIONS

We recommend printing at full-scale to check the fit with your tools before ordering.

Option 1: Print this page full-scale on a large-format printer (E-Size, 44 inches X 34 inches).

Option 2: Print page 2 - 13 on 8-1/2 X 11 inch paper and assemble.

Thank You!

THE INFORMATION CONTAINED ON THIS DRAWING IS THE SOLE PROPERTY OF FOAMFIT TOOLS AND MAY NOT BE USED WITHOUT PERMISSION. Copyright 2024 FoamFit Tools

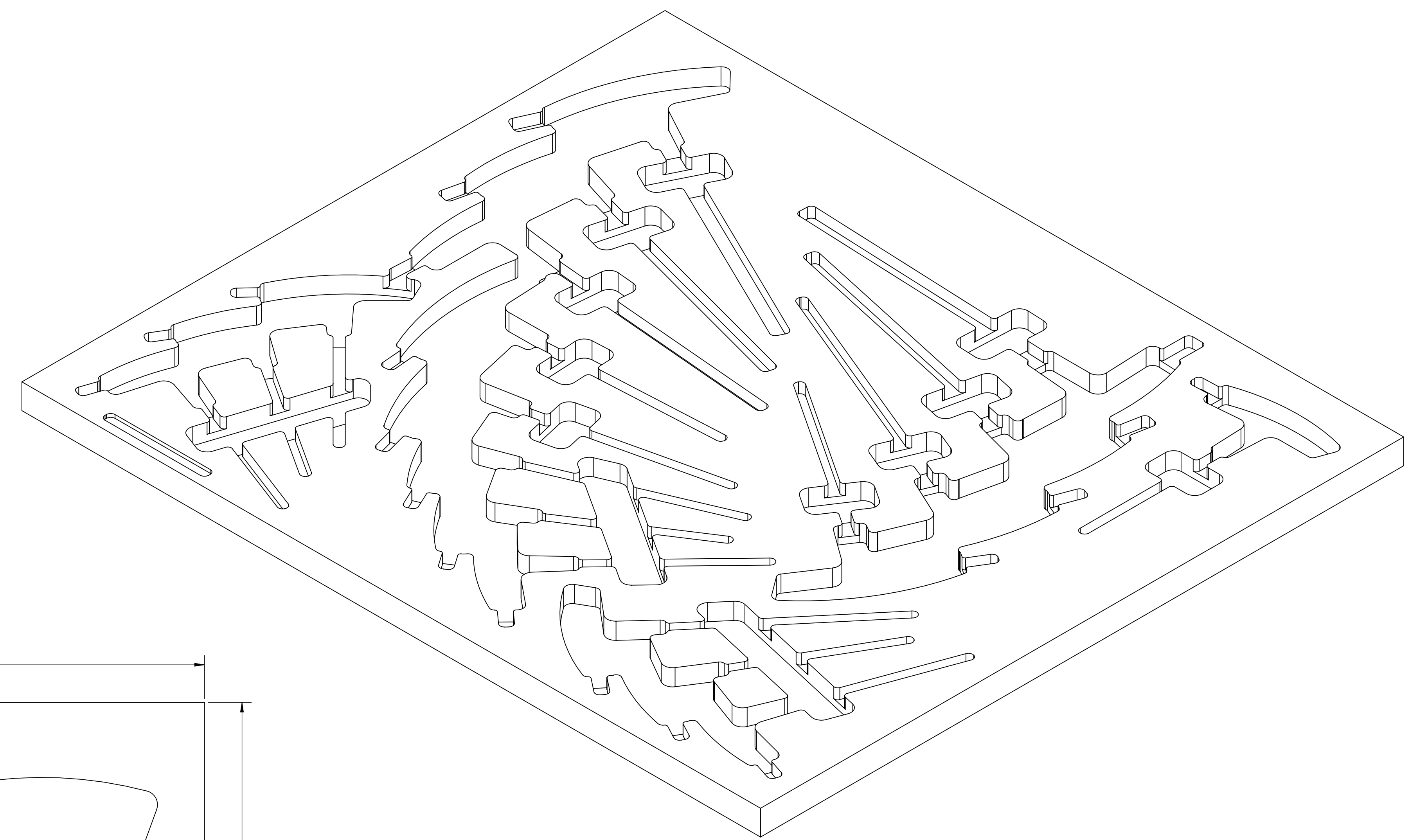

5.00 IN

PART NUMBER F-05831-R

← 1.00 IN →

PAGE KEY

X					

↑ 1.00 IN ↓

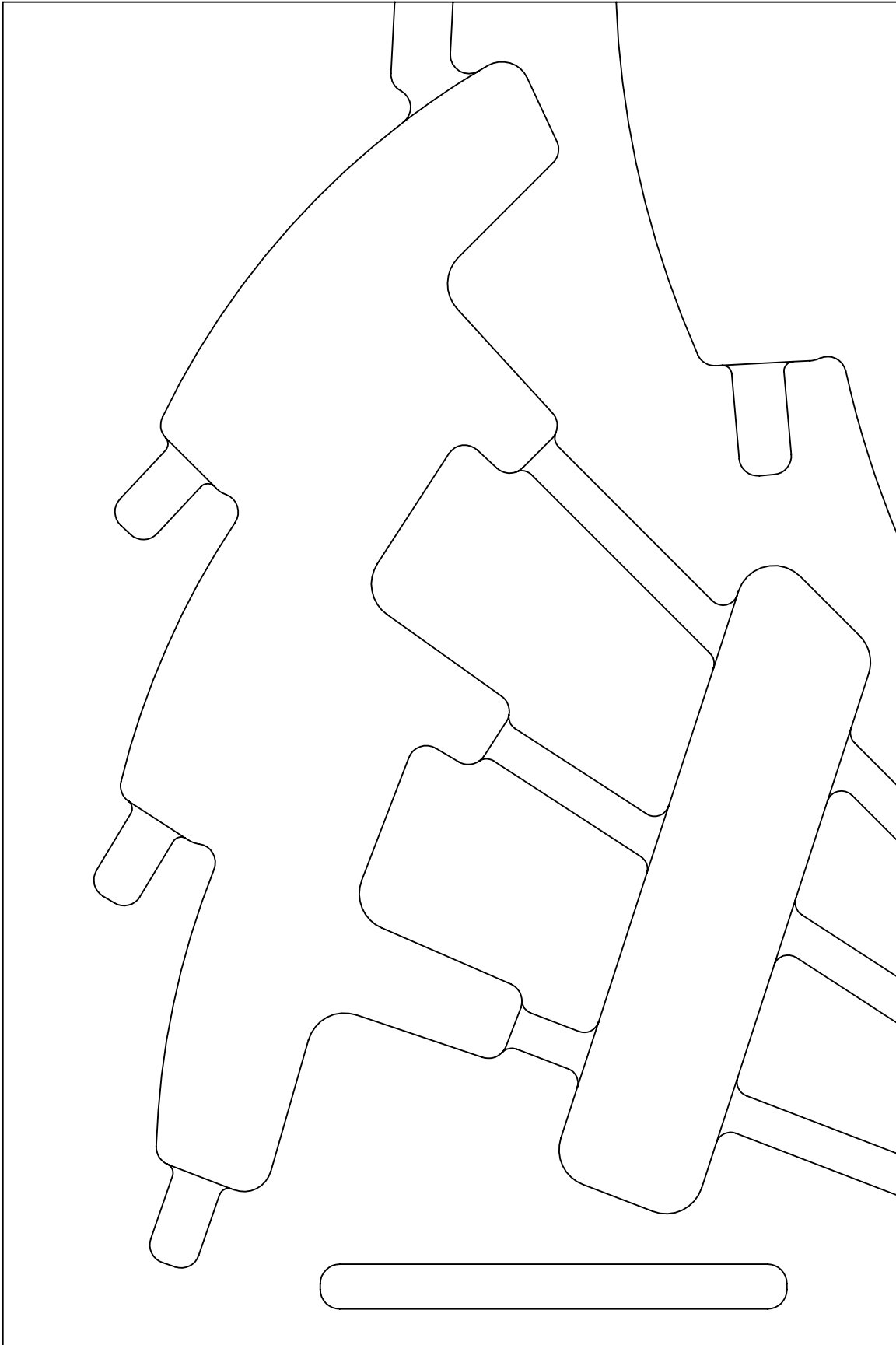

Print on Letter at 100%

DATE CREATED

14 OCT 2024

PART NUMBER

F-05831-R

← 1.00 IN →

PAGE KEY



↑ 1.00 IN ↓

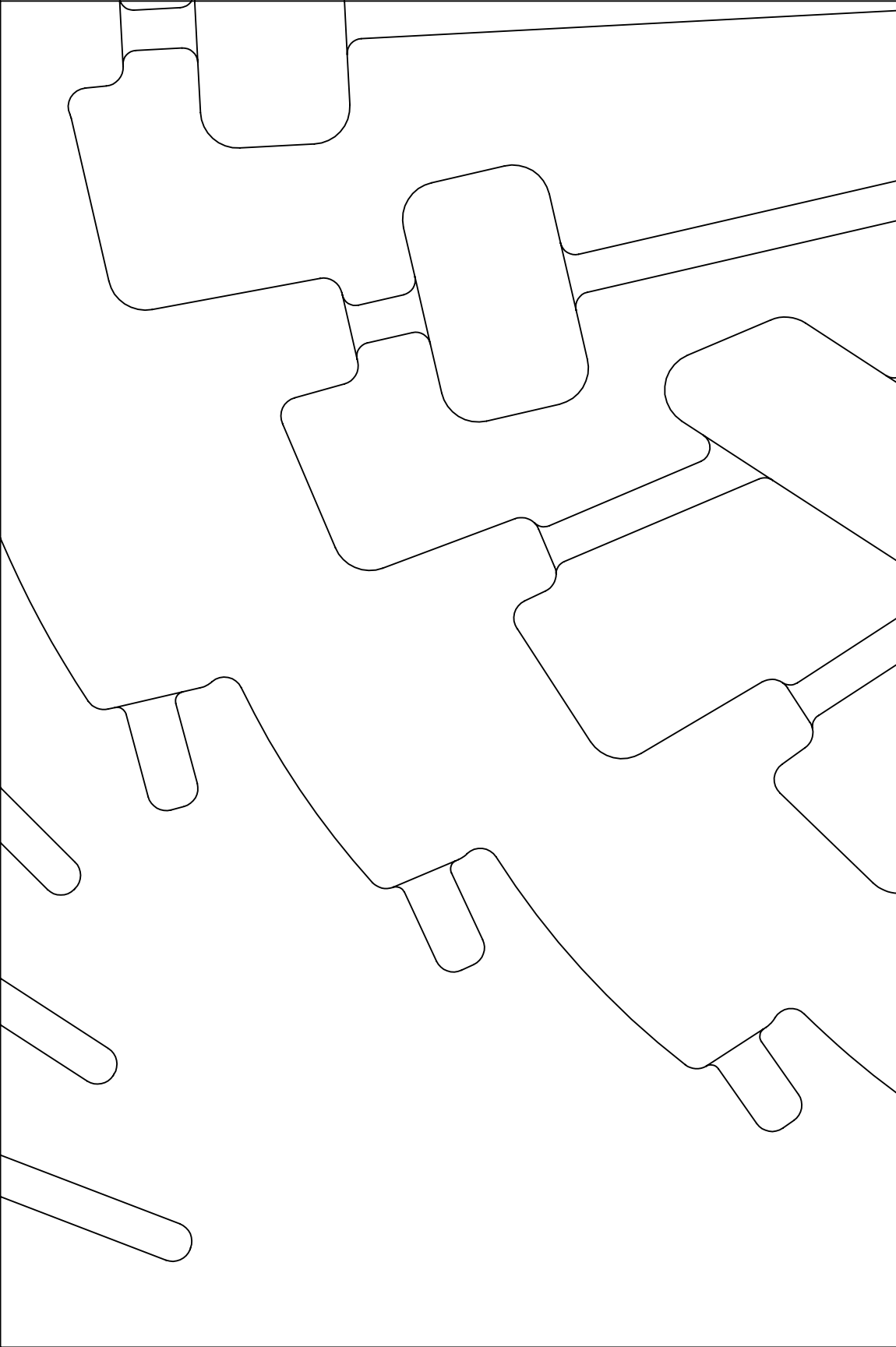

Print on Letter at 100%

DATE CREATED

14 OCT 2024

PART NUMBER

F-05831-R

1.00 IN

PAGE KEY



1.00 IN

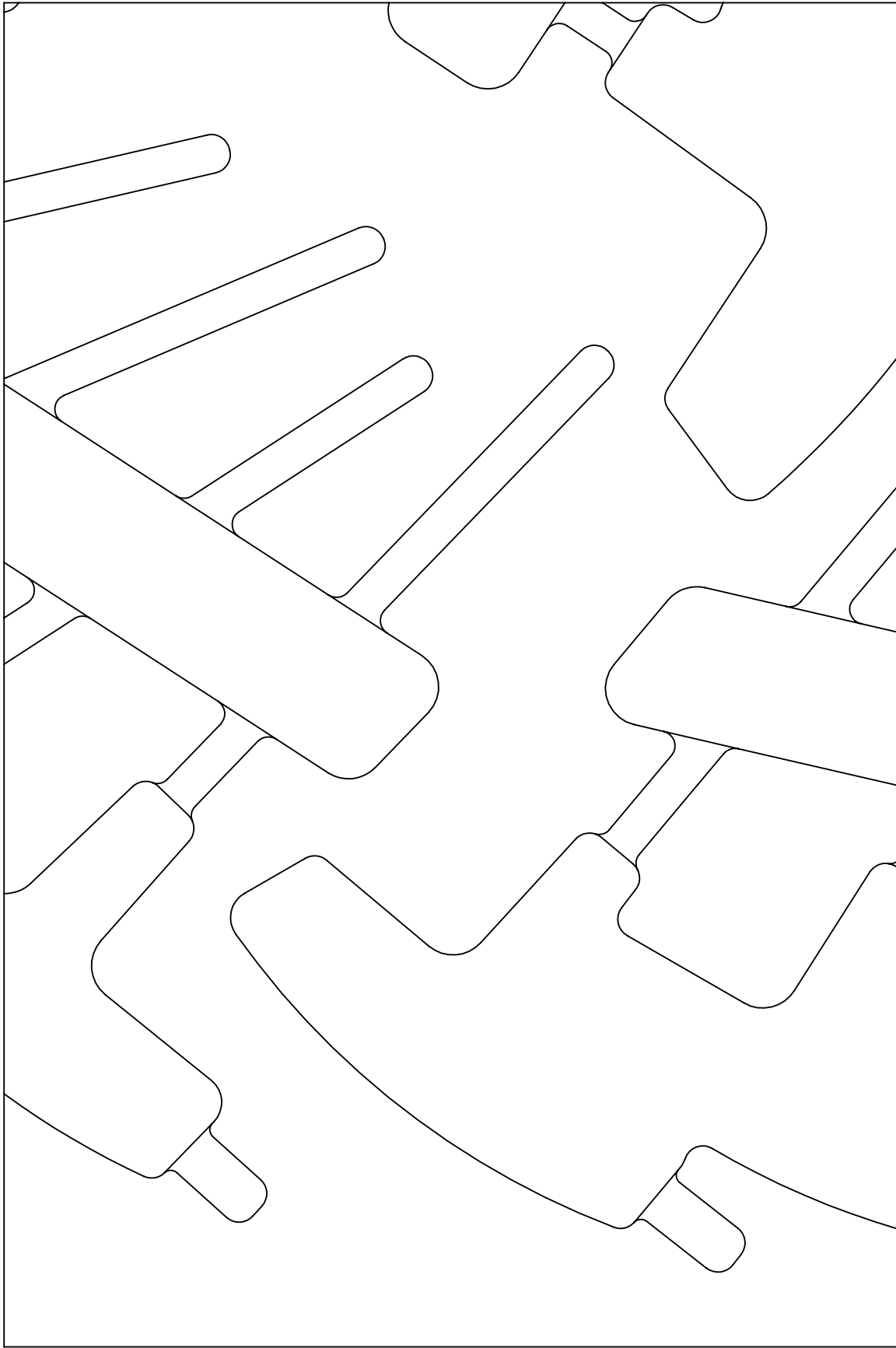

Print on Letter at 100%

DATE CREATED

14 OCT 2024

PART NUMBER

F-05831-R

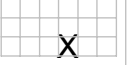

Print on Letter at 100%

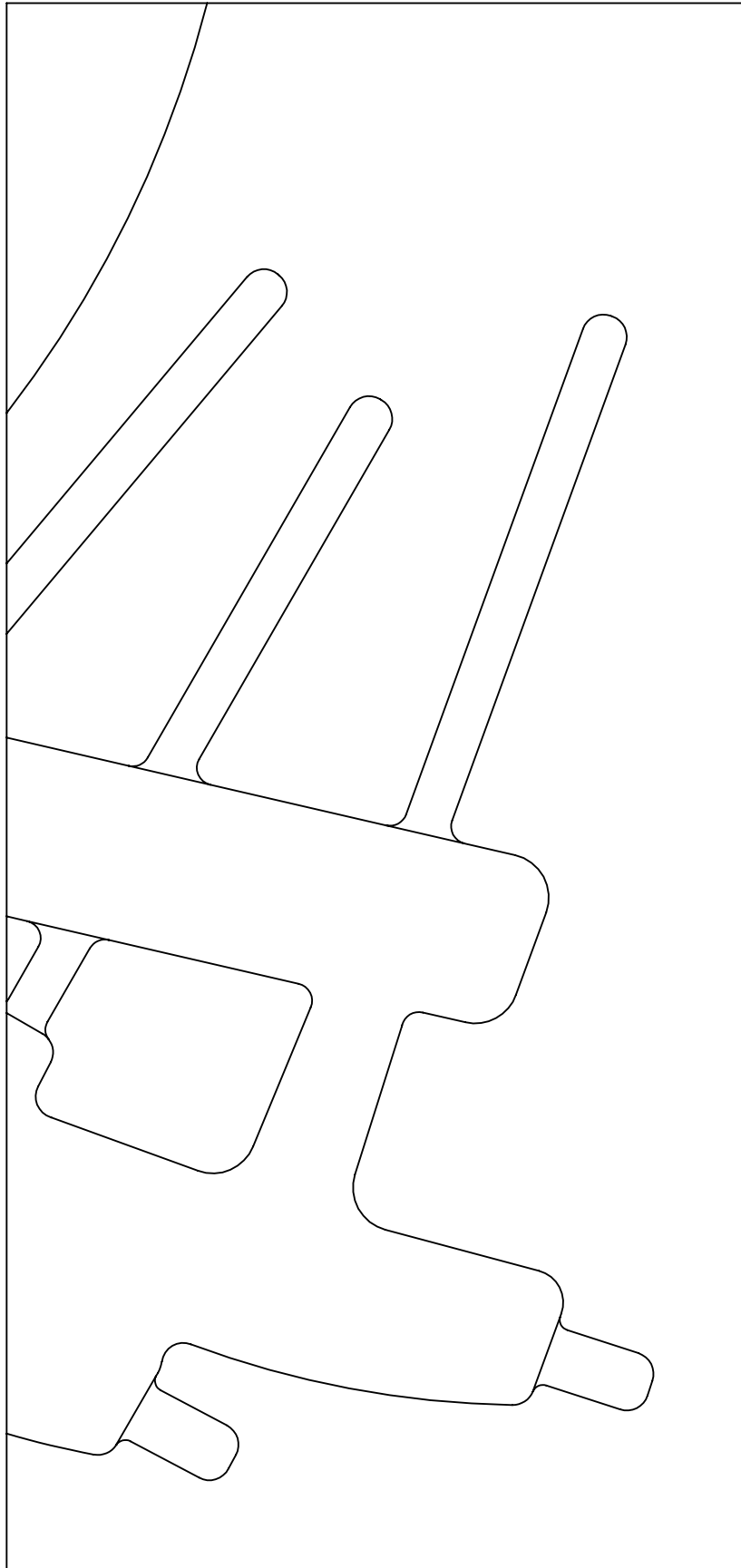

PART NUMBER

F-05831-R

DATE CREATED

14 OCT 2024

1.00 IN

PAGE KEY

X									
---	--	--	--	--	--	--	--	--	--

1.00
IN

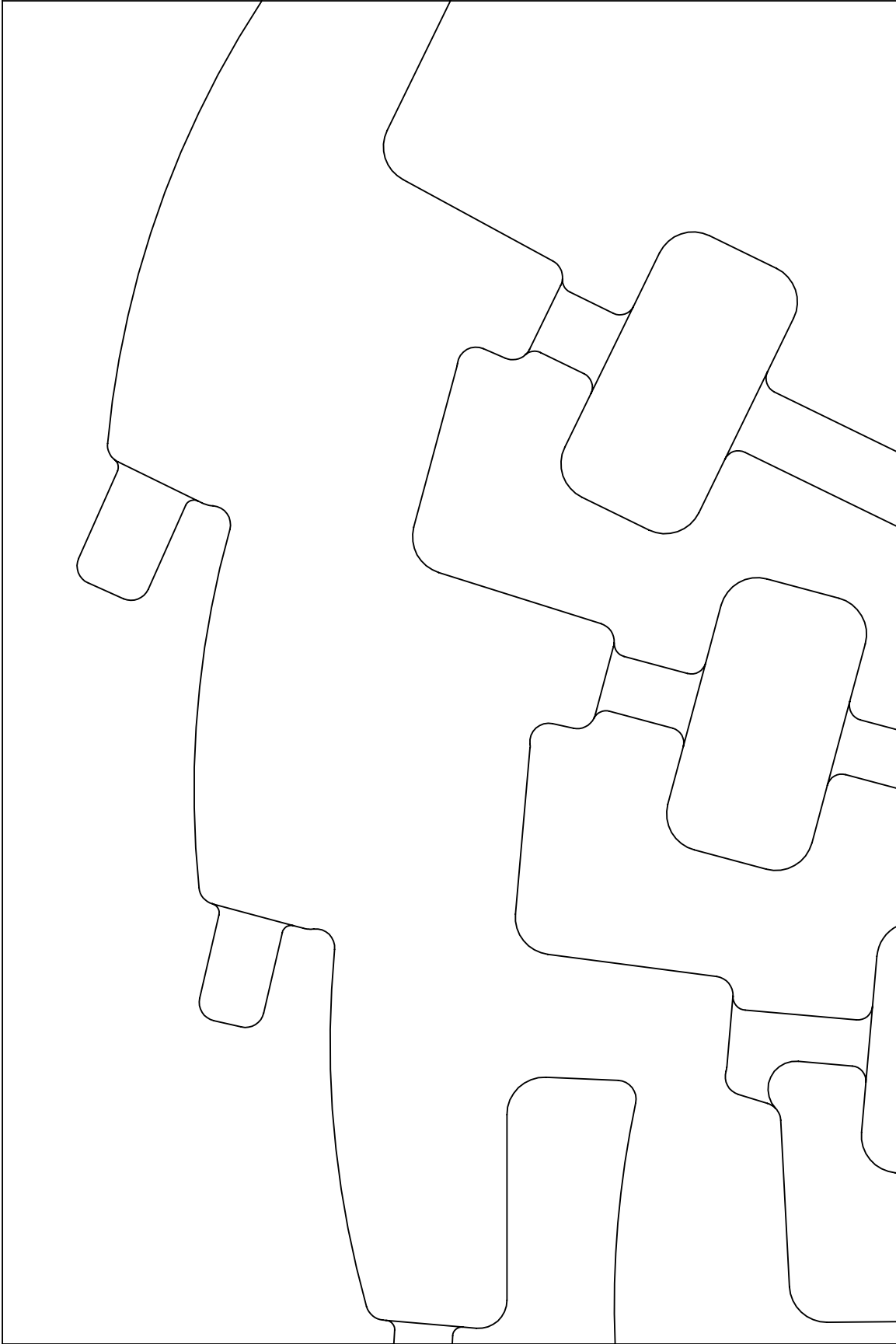

Print on Letter at 100%

DATE CREATED

14 OCT 2024

PART NUMBER

F-05831-R

← 1.00 IN →

↑ 1.00 IN ↓

PAGE KEY

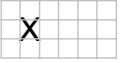

Print on Letter at 100%

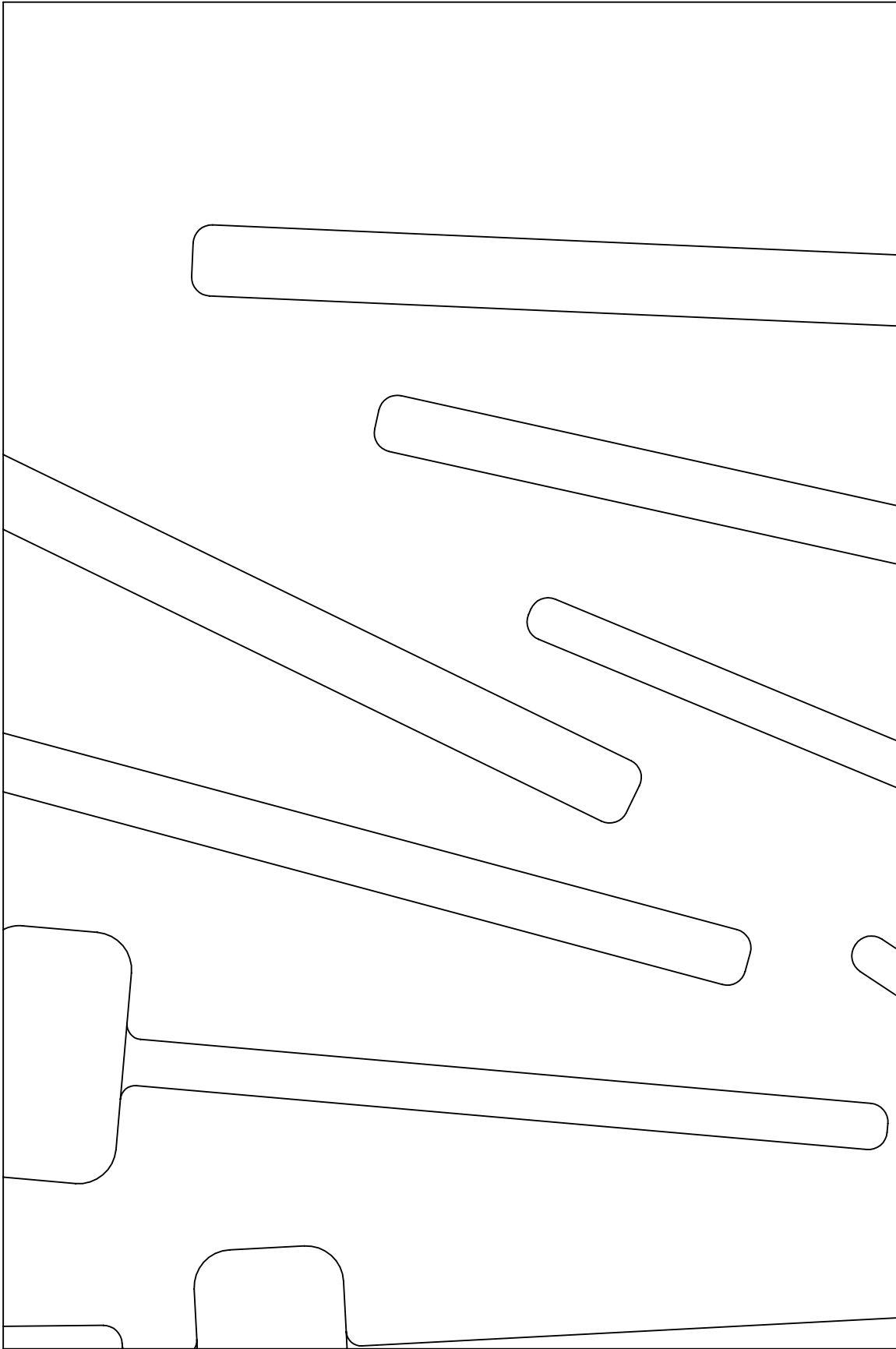

DATE CREATED

14 OCT 2024

PART NUMBER

F-05831-R

← 1.00 IN →

PAGE KEY



↑ 1.00 IN ↓

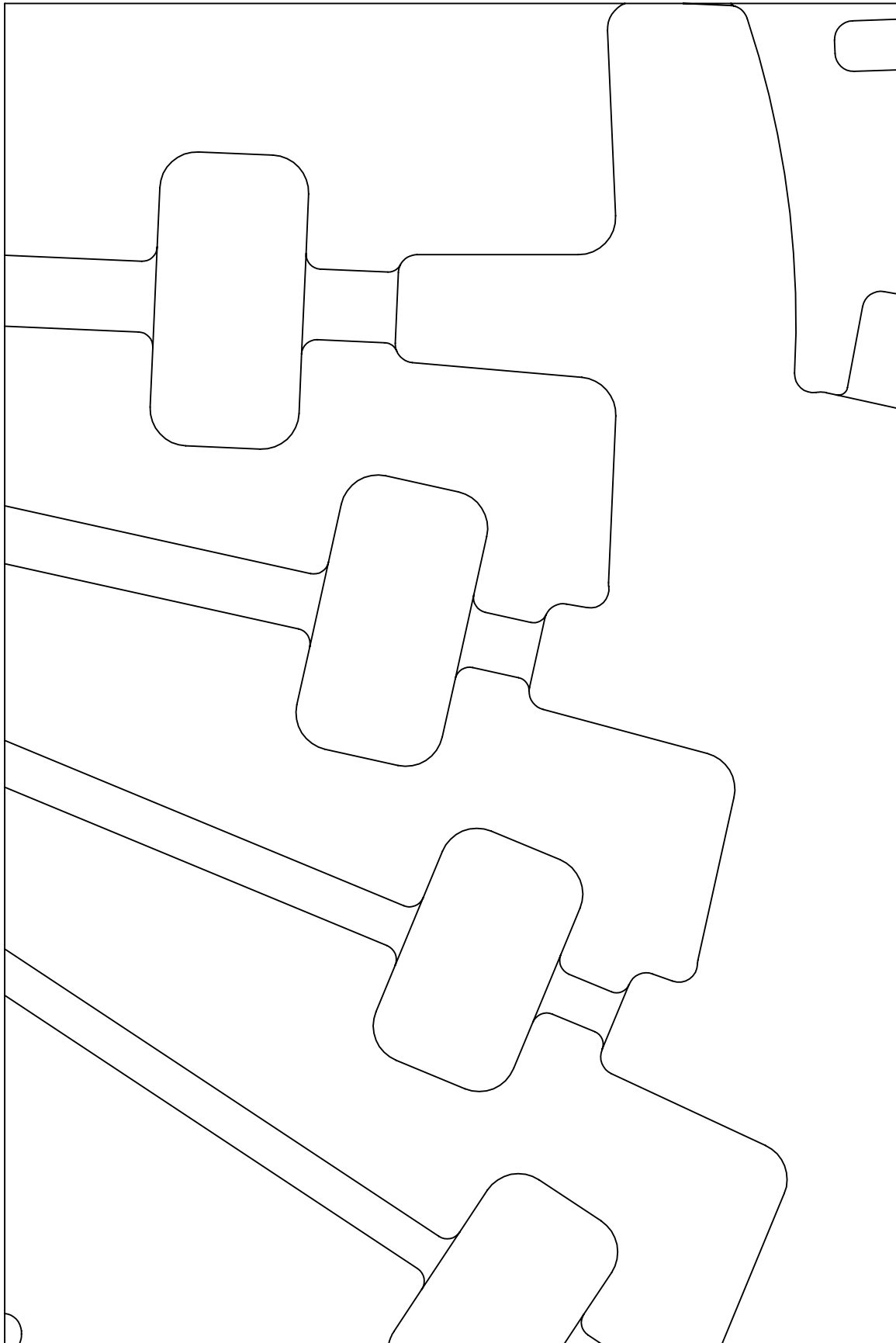

Print on Letter at 100%

DATE CREATED

14 OCT 2024

PART NUMBER

F-05831-R

Print on Letter at 100%

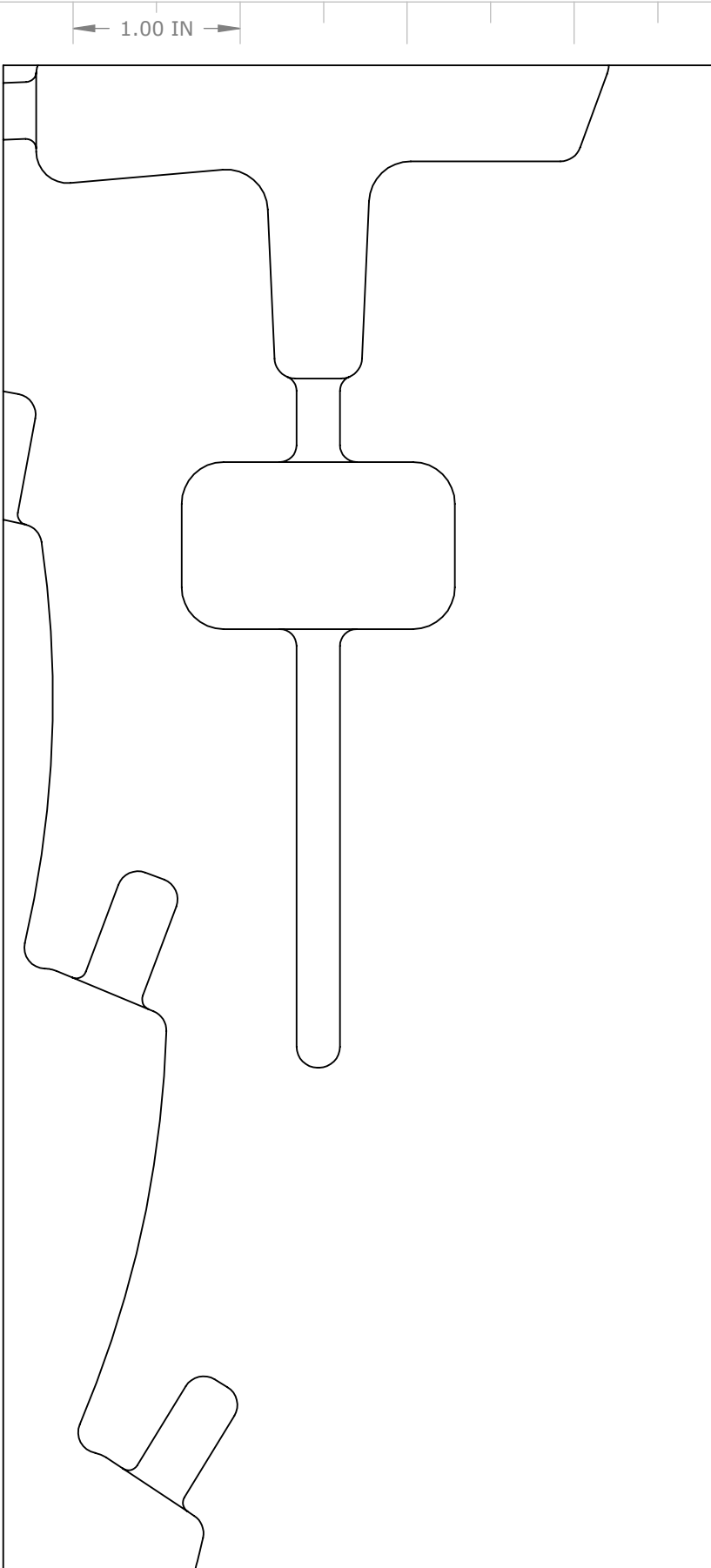

PAGE KEY

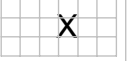

DATE CREATED

14 OCT 2024

PART NUMBER

F-05831-R

1.00 IN

PAGE KEY

X									

1.00
IN

Print on Letter at 100%

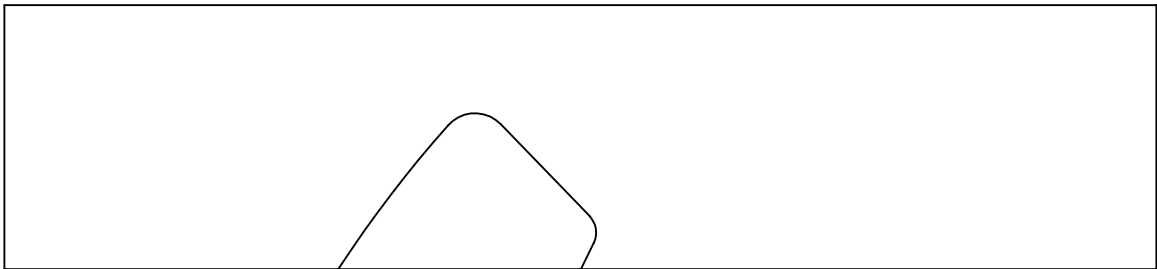

DATE CREATED

14 OCT 2024

PART NUMBER

F-05831-R

1.00 IN

PAGE KEY

X									

1.00
IN

DATE CREATED
14 OCT 2024

PART NUMBER
F-05831-R

Print on Letter at 100%



← 1.00 IN →

PAGE KEY



↑
1.00
IN
↓

Print on Letter at 100%

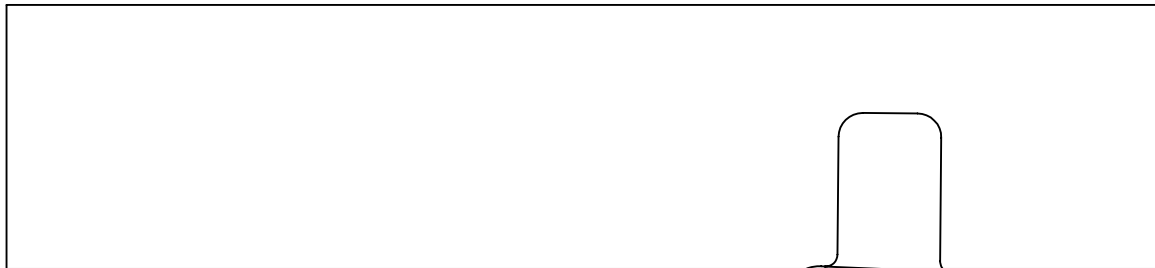

DATE CREATED
14 OCT 2024

PART NUMBER
F-05831-R

← 1.00 IN →

PAGE KEY



↑
1.00
IN
↓

DATE CREATED
14 OCT 2024

PART NUMBER
F-05831-R

Print on Letter at 100%

