

PRINTING INSTRUCTIONS

We recommend printing at full-scale to check the fit with your tools before ordering.

Option 1: Print this page full-scale on a large-format printer (E-Size, 44 inches X 34 inches).

Option 2: Print page 2 - 13 on 8-1/2 X 11 inch paper and assemble.

Thank You!

THE INFORMATION CONTAINED ON THIS DRAWING IS THE SOLE PROPERTY OF FOAMFIT TOOLS AND MAY NOT BE USED WITHOUT PERMISSION. Copyright 2016 FoamFit Tools

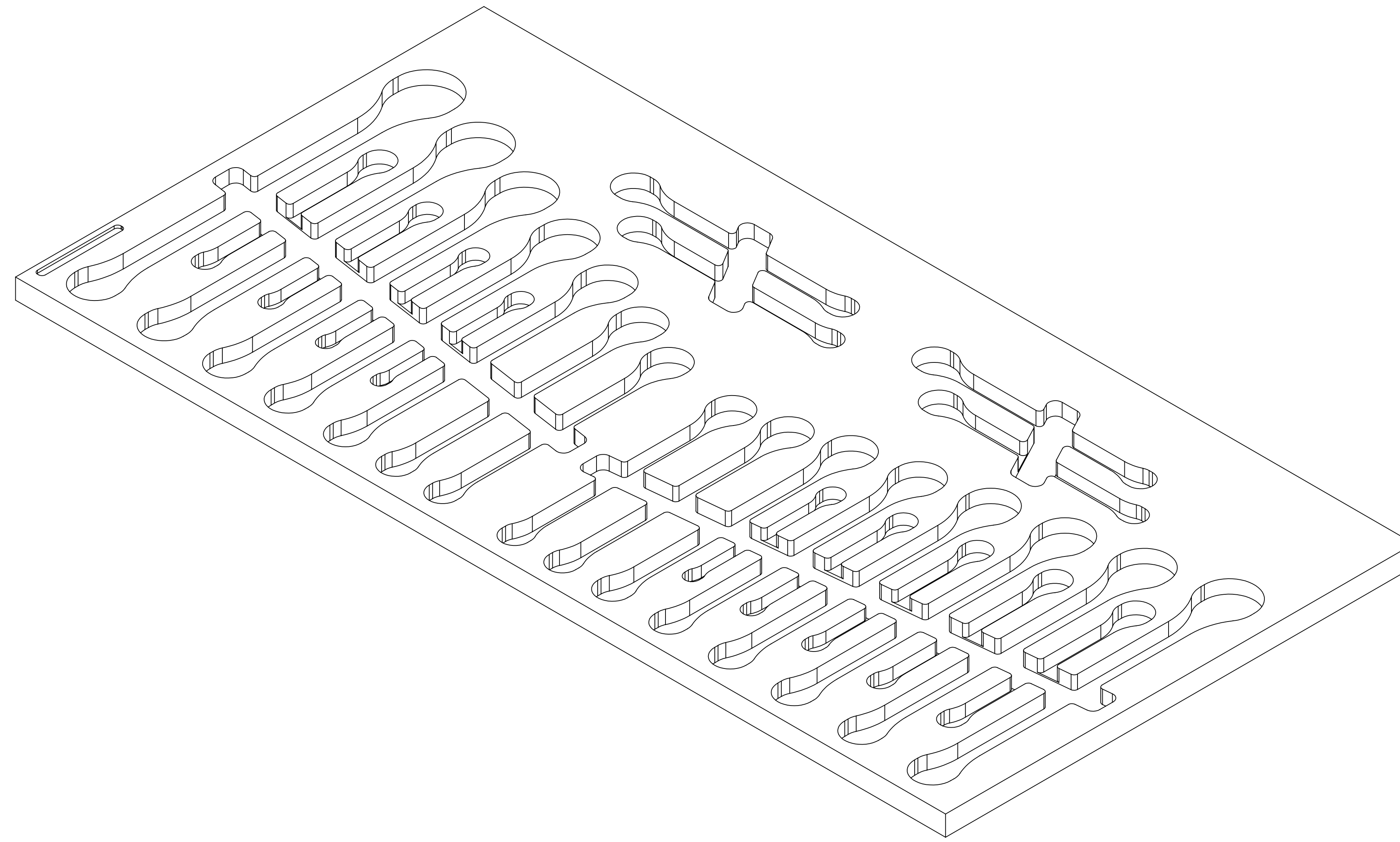

5.00 IN

5.00 IN

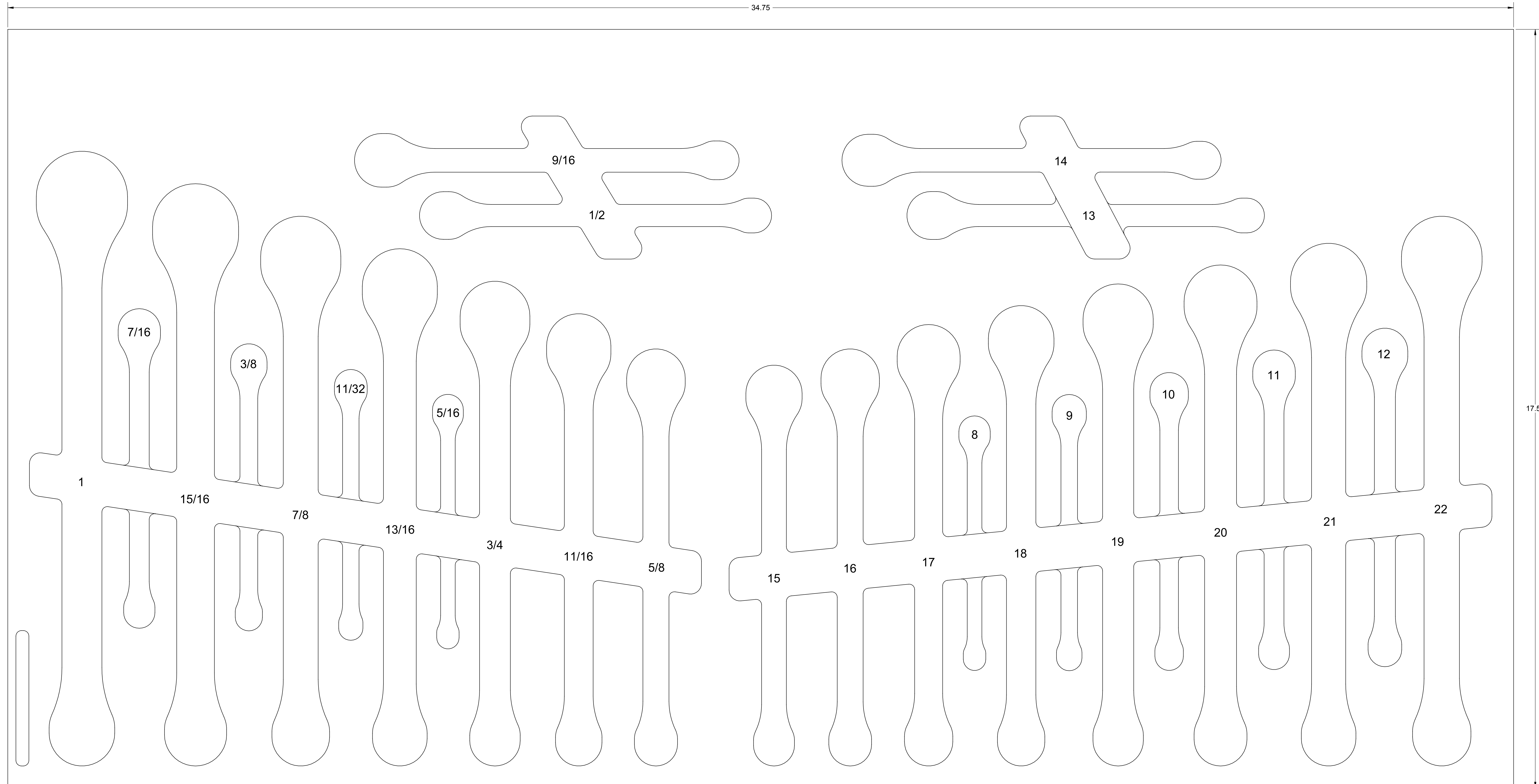

34.75

17.50

PART NUMBER **F1A-01480**

PART NUMBER

Print on Letter at 100%

1.00
IN

1.00 IN

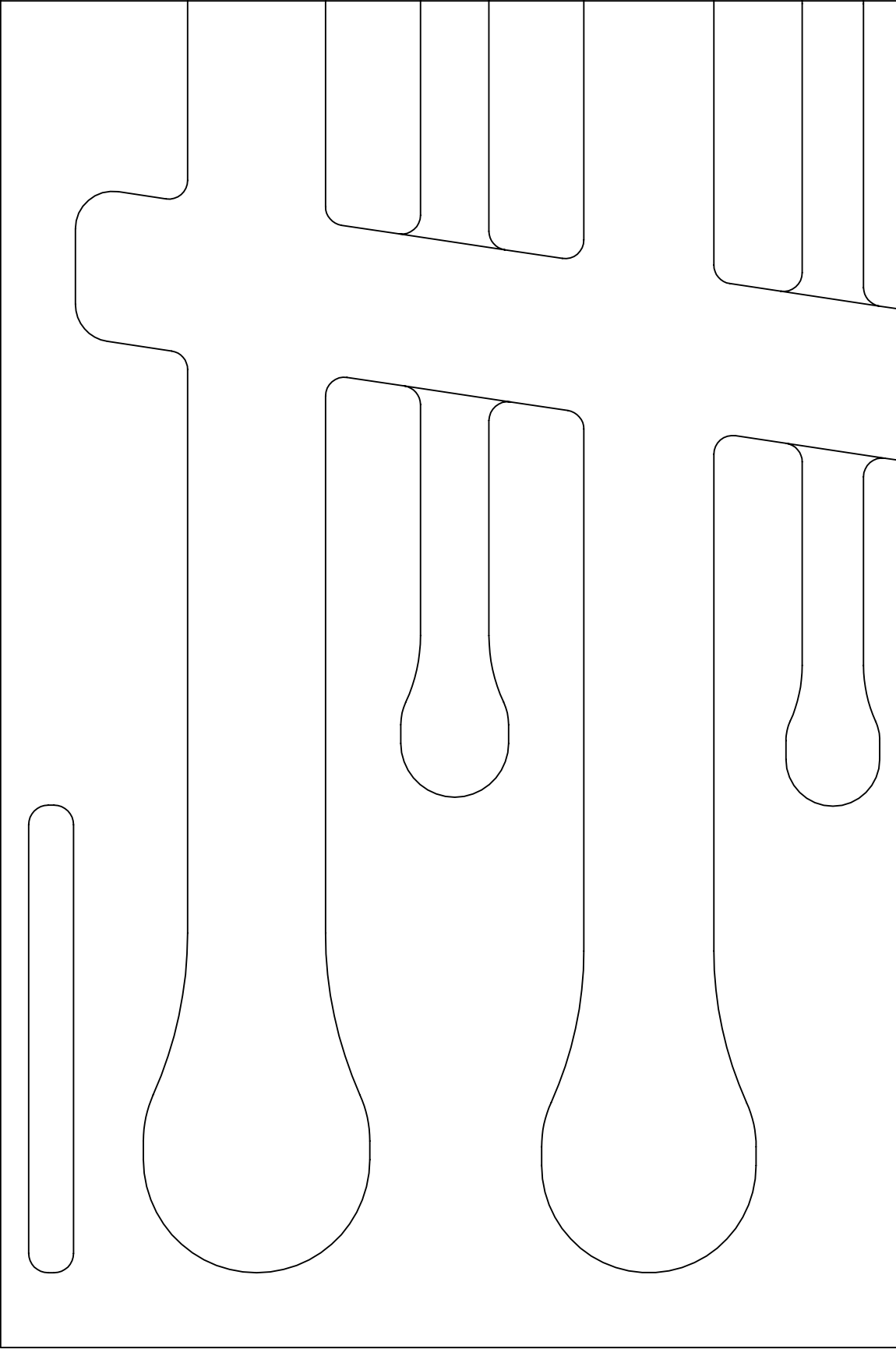

PAGE KEY



DATE CREATED

06 JUN 2016

PART NUMBER

F1A-01480

Print on Letter at 100%

1.00
IN

1.00 IN

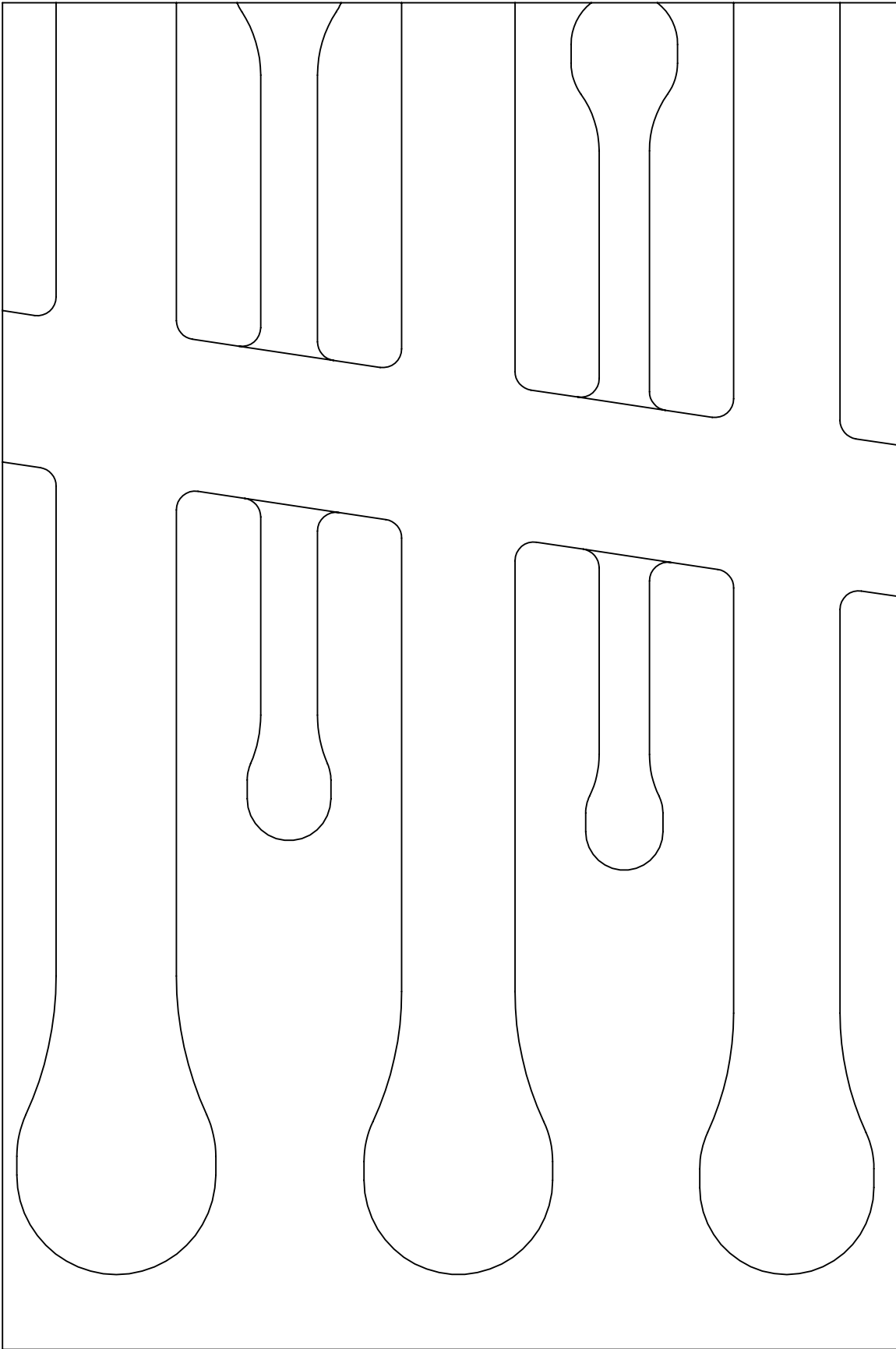

PAGE KEY



DATE CREATED

06 JUN 2016

PART NUMBER

F1A-01480

Print on Letter at 100%

1.00 IN

1.00
IN

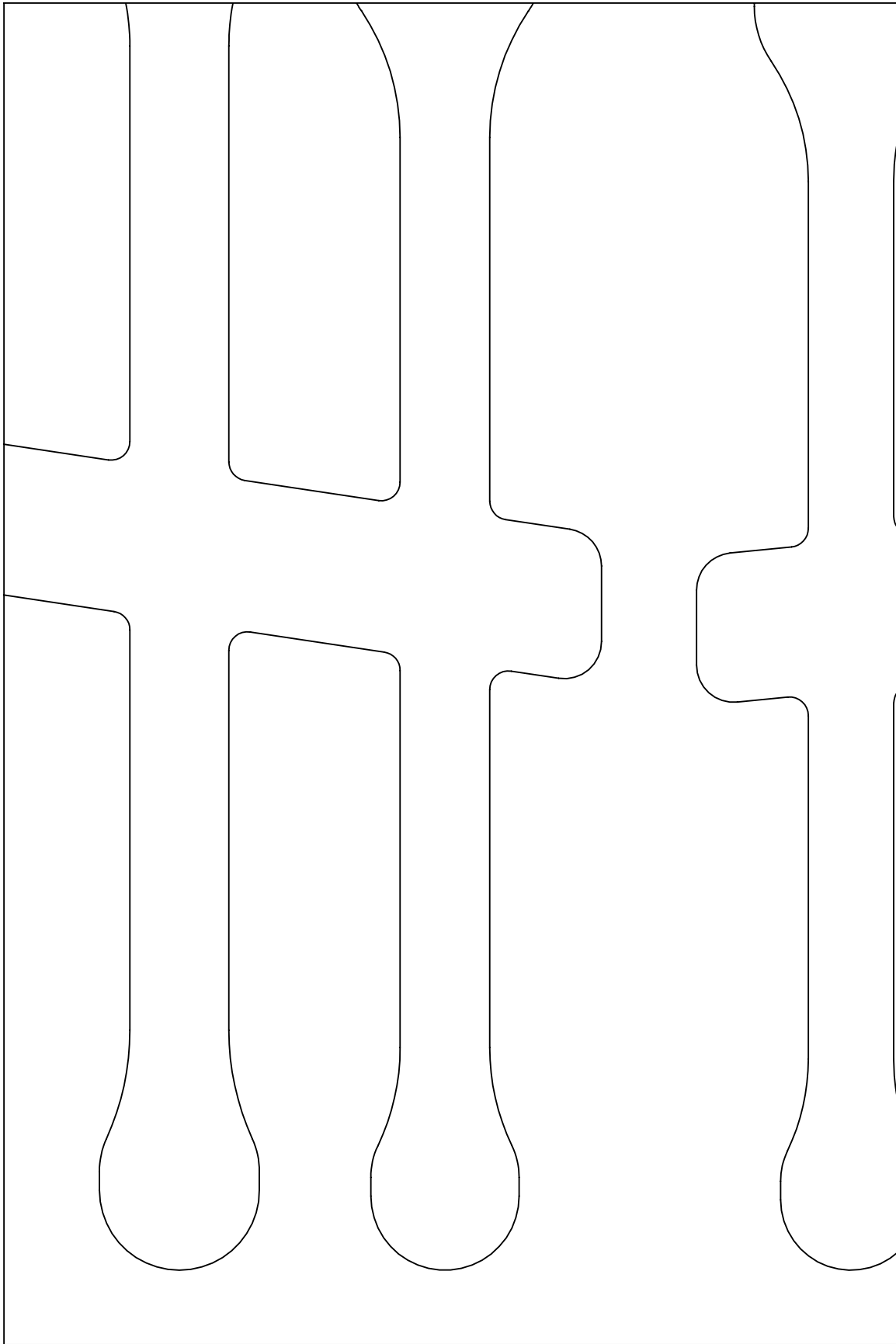

PAGE KEY



DATE CREATED

06 JUN 2016

PART NUMBER

F1A-01480

Print on Letter at 100%

1.00
IN

1.00 IN

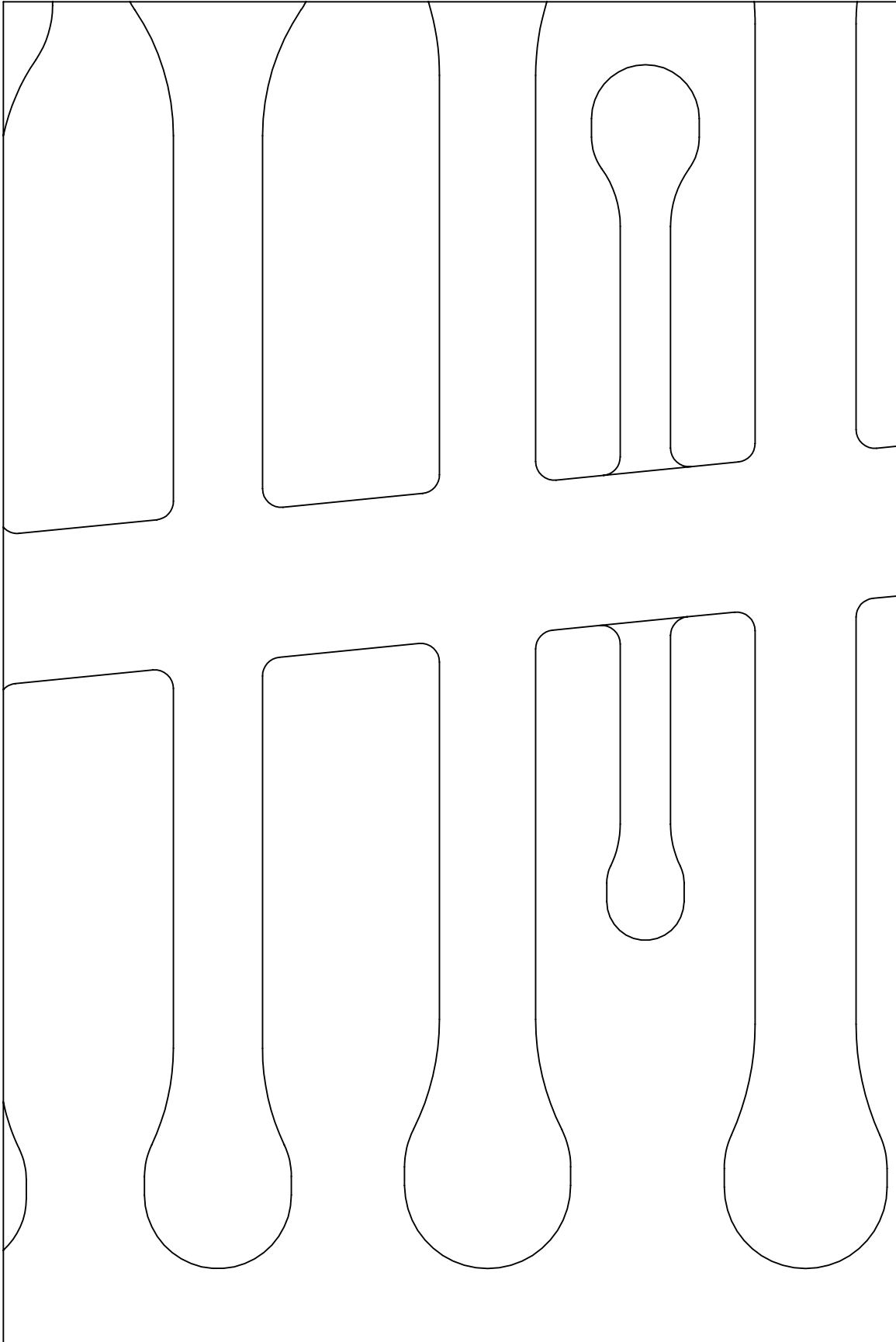

PAGE KEY



DATE CREATED

06 JUN 2016

PART NUMBER

F1A-01480

Print on Letter at 100%

1.00 IN

1.00 IN

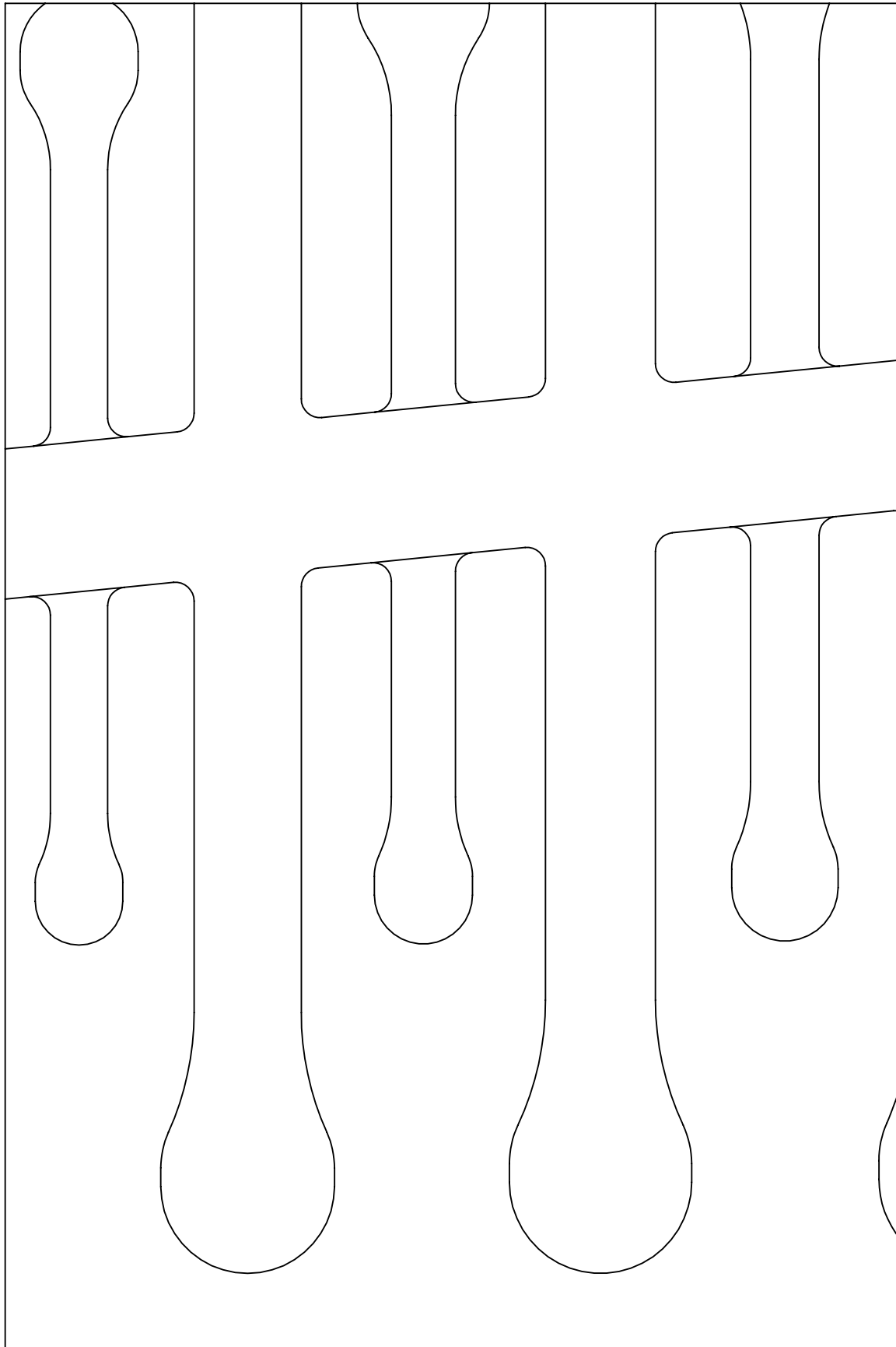

PAGE KEY

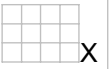

DATE CREATED

06 JUN 2016

PART NUMBER

F1A-01480

Print on Letter at 100%

1.00
IN

1.00 IN

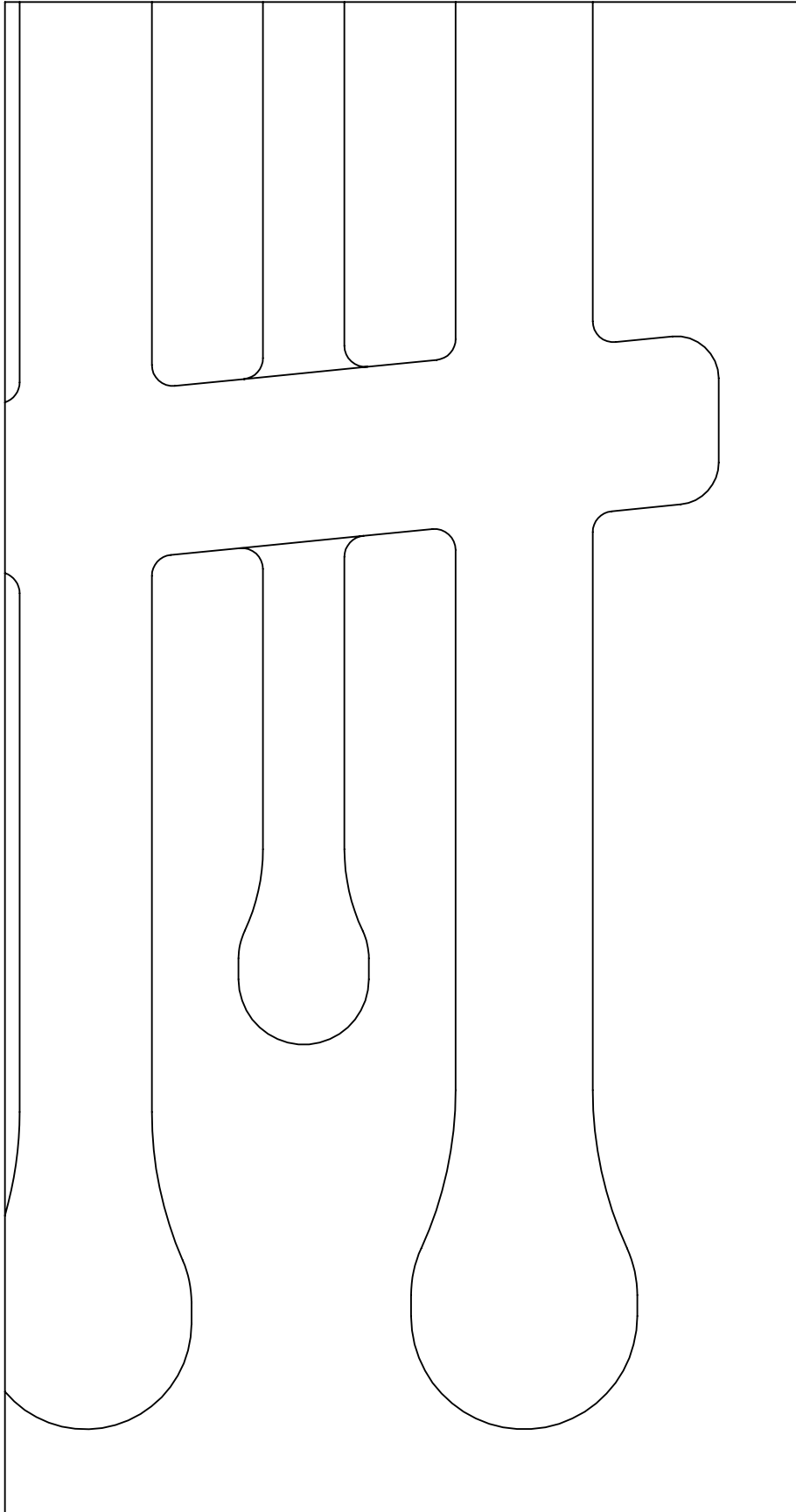

PAGE KEY



X

DATE CREATED

06 JUN 2016

PART NUMBER

F1A-01480

1.00 IN

PAGE KEY



1.00
IN

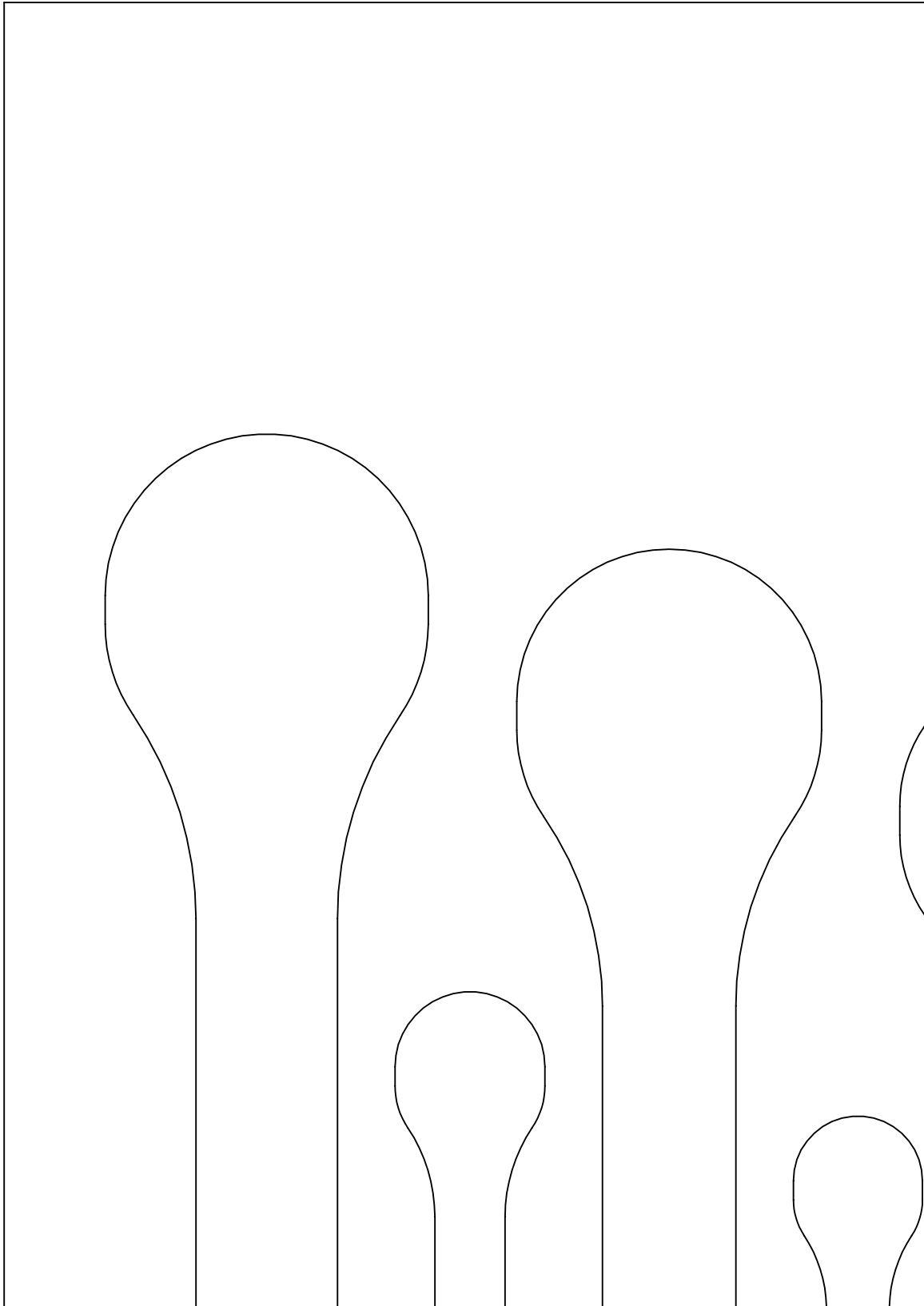

Print on Letter at 100%

DATE CREATED

06 JUN 2016

PART NUMBER

F1A-01480

1.00 IN

PAGE KEY



1.00
IN

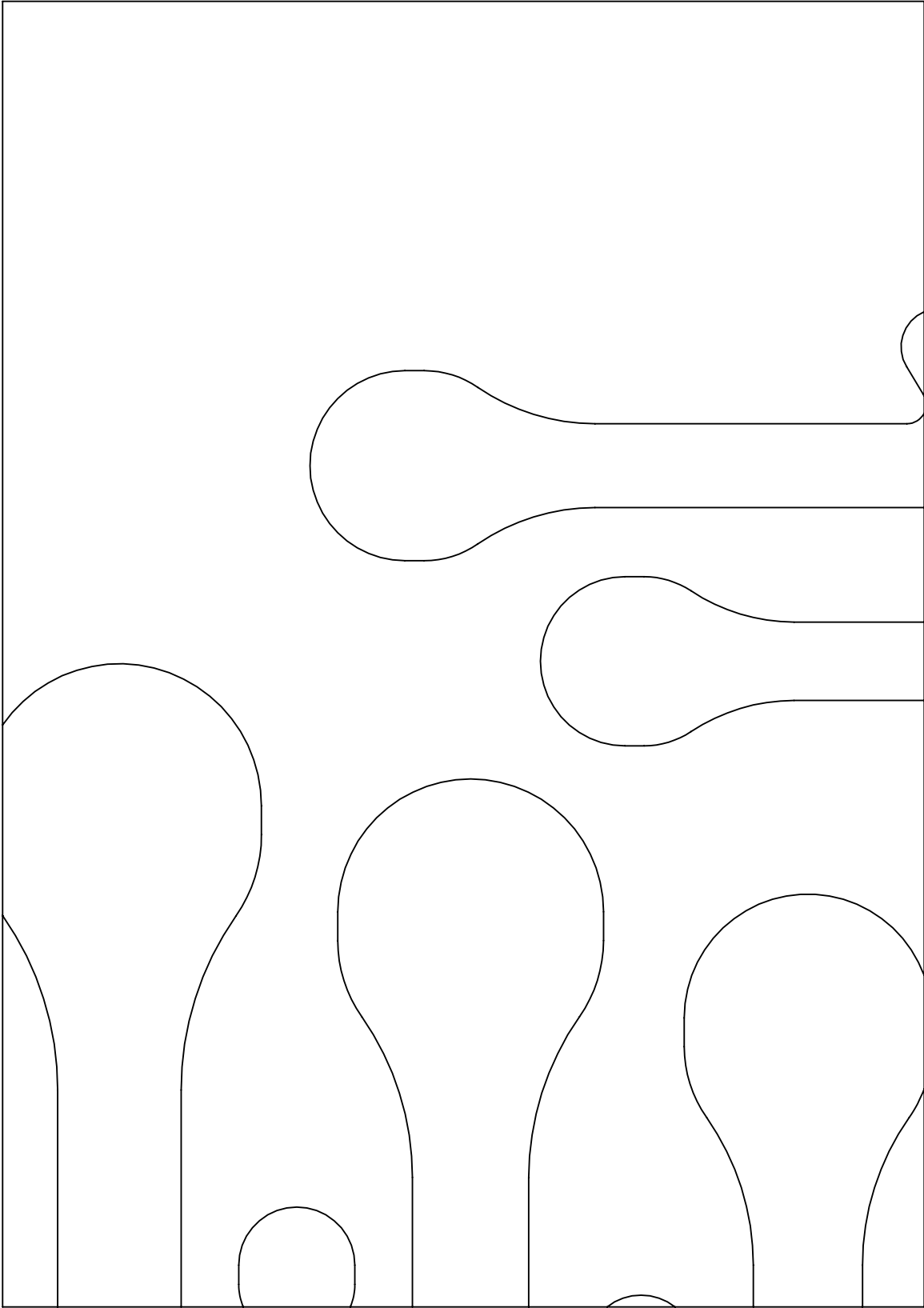

Print on Letter at 100%

DATE CREATED

06 JUN 2016

PART NUMBER

F1A-01480

1.00 IN

PAGE KEY



1.00
IN

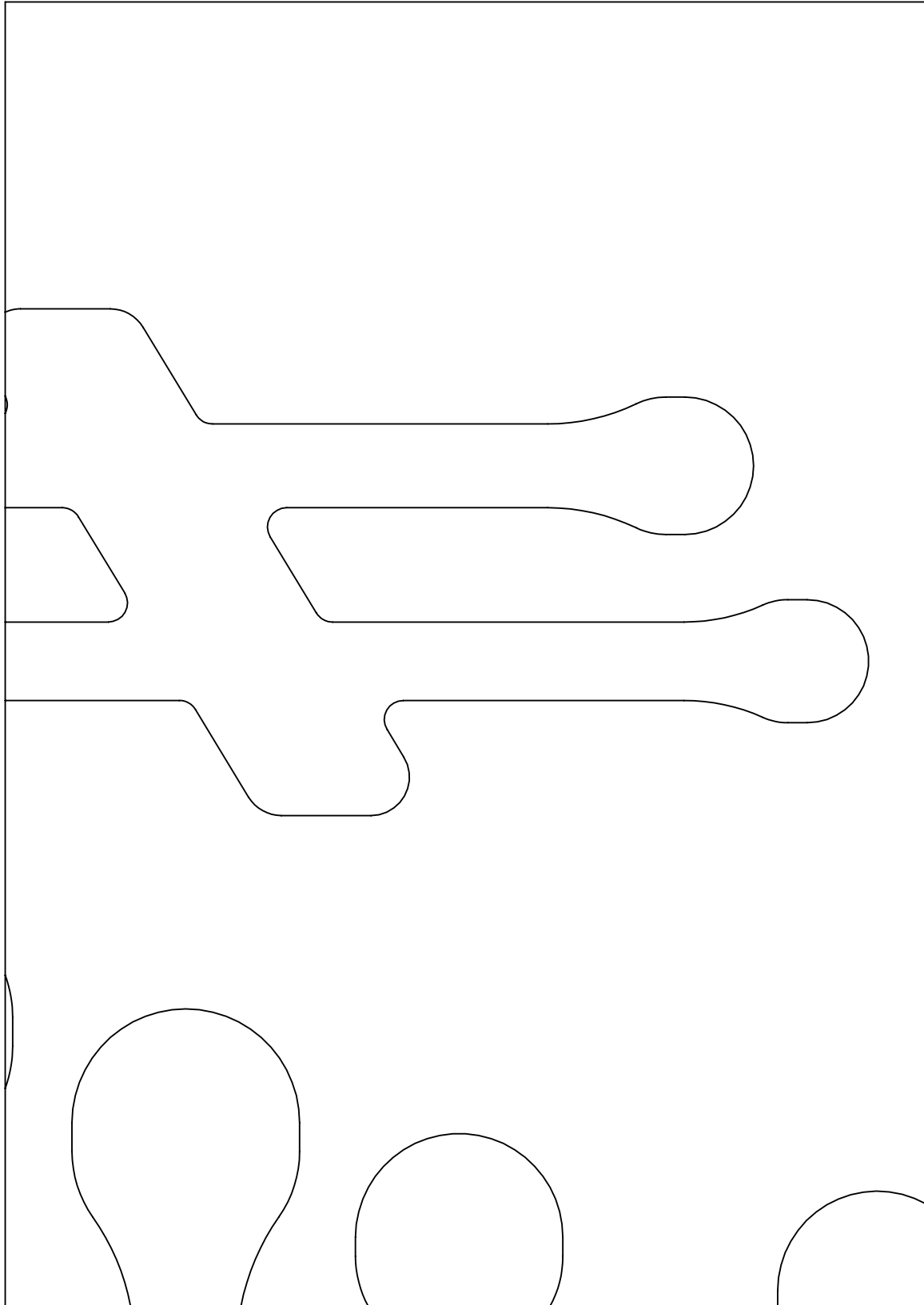

Print on Letter at 100%

DATE CREATED

06 JUN 2016

PART NUMBER

F1A-01480

1.00 IN

PAGE KEY



1.00
IN

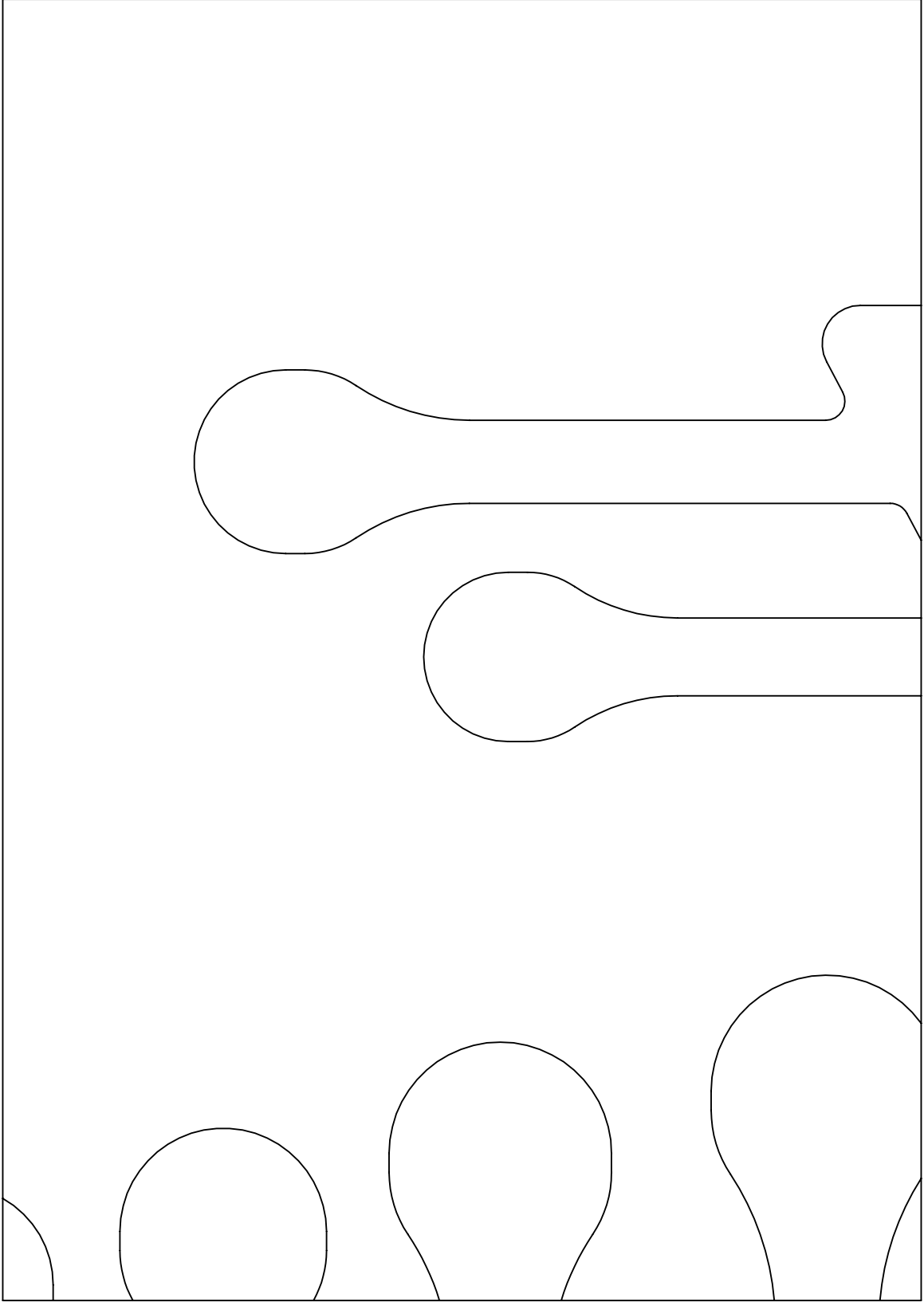

Print on Letter at 100%

DATE CREATED

06 JUN 2016

PART NUMBER

F1A-01480

1.00 IN

PAGE KEY

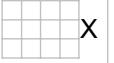

1.00
IN

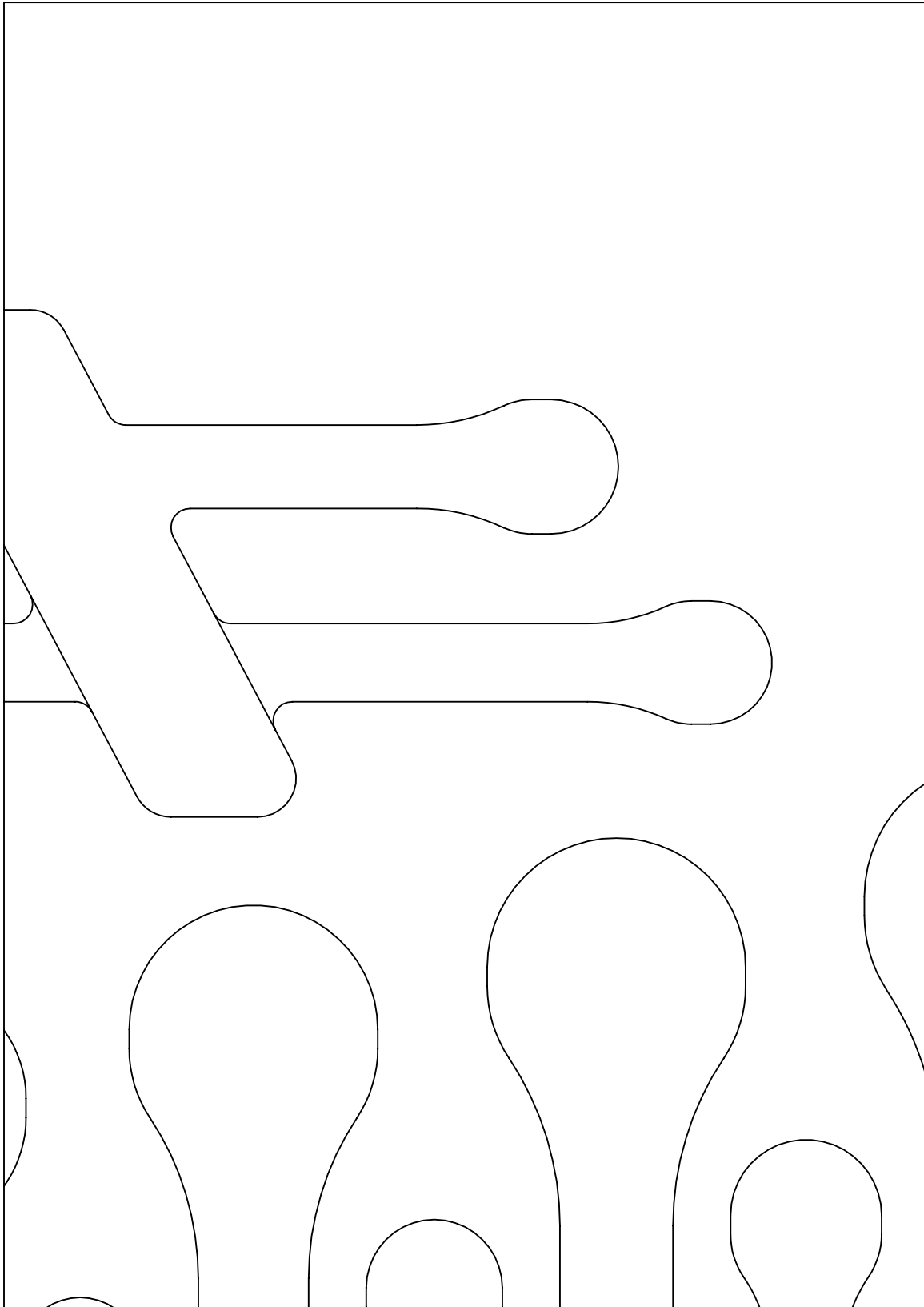

Print on Letter at 100%

DATE CREATED

06 JUN 2016

PART NUMBER

F1A-01480

1.00 IN

PAGE KEY



X

1.00
IN

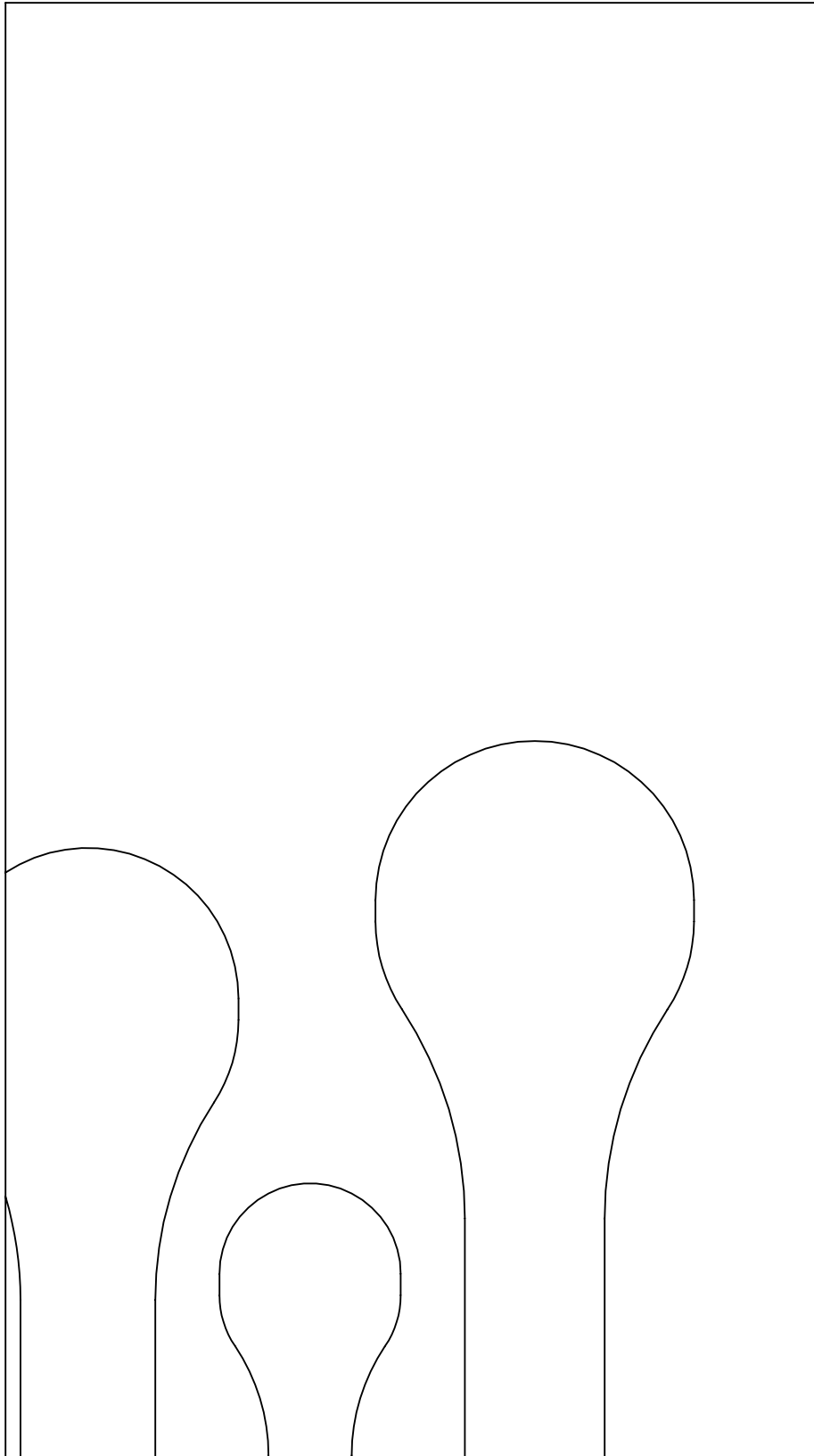

Print on Letter at 100%

DATE CREATED

06 JUN 2016

PART NUMBER

F1A-01480

