

PRINTING INSTRUCTIONS

We recommend printing at full-scale to check the fit with your tools before ordering.

Option 1: Print this page full-scale on a large-format printer (D-Size, 34 inches X 22 inches).

Option 2: Print page 2 - 9 on 8-1/2 X 11 inch paper and assemble.

Thank You!

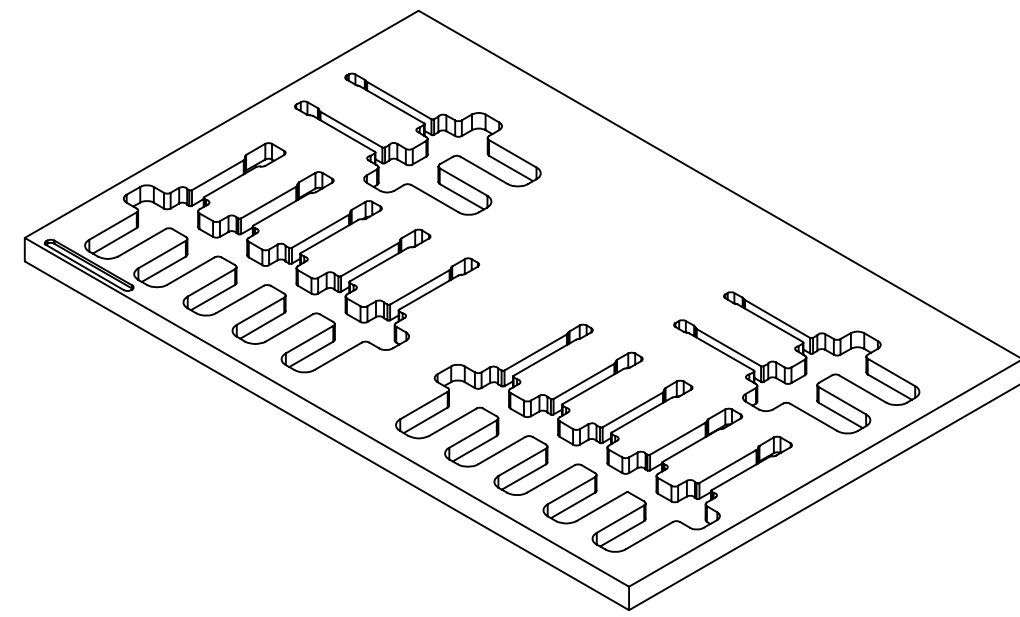

5.00 IN

THE INFORMATION CONTAINED ON THIS DRAWING IS THE SOLE PROPERTY OF FOAMFIT TOOLS AND MAY NOT BE USED WITHOUT PERMISSION.
Copyright 2013 FoamFit Tools

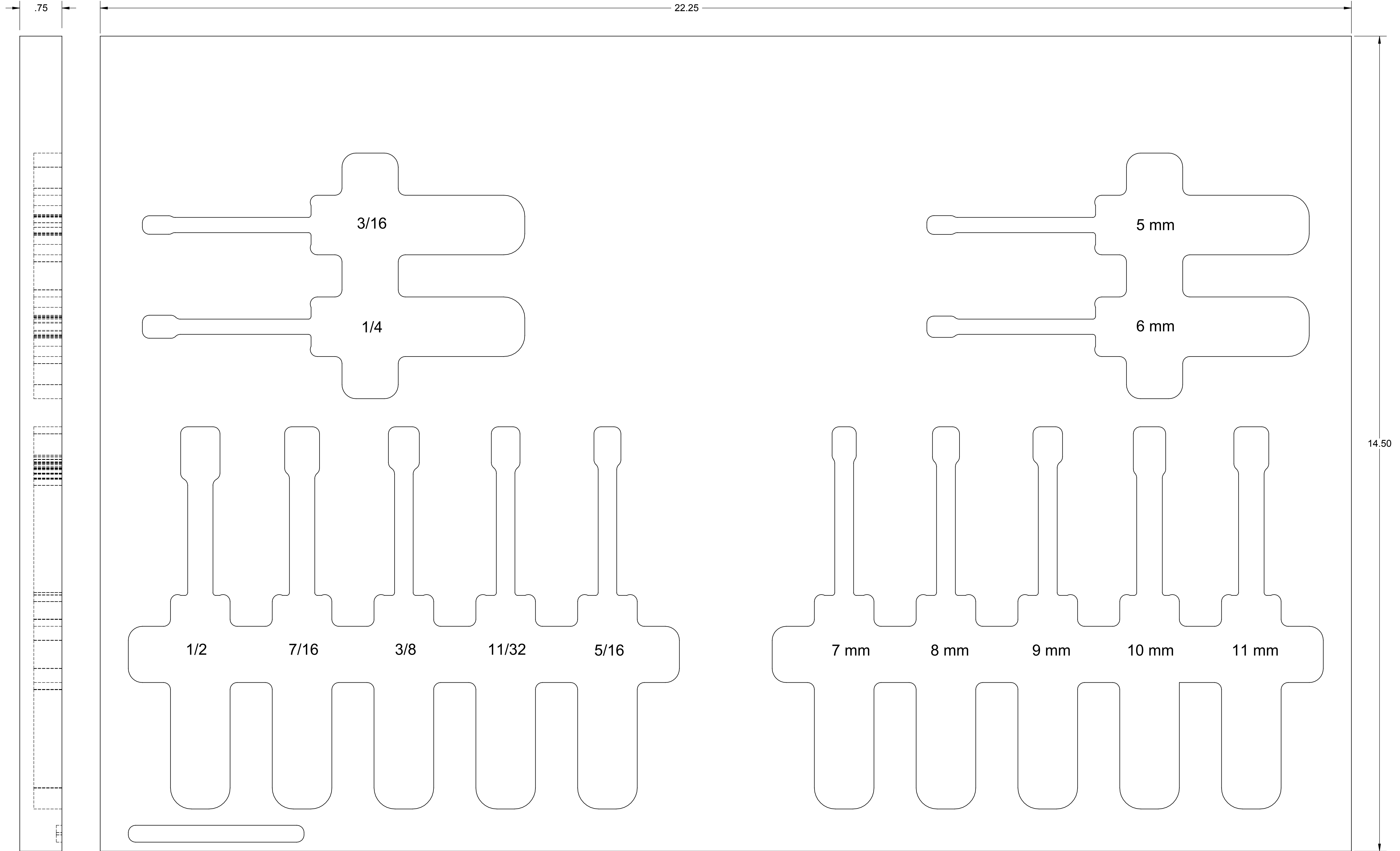

PART NUMBER
F1M-00530

CRAFTSMAN NUTDRIVERS

1.00 IN

PAGE KEY

X									

1.00
IN

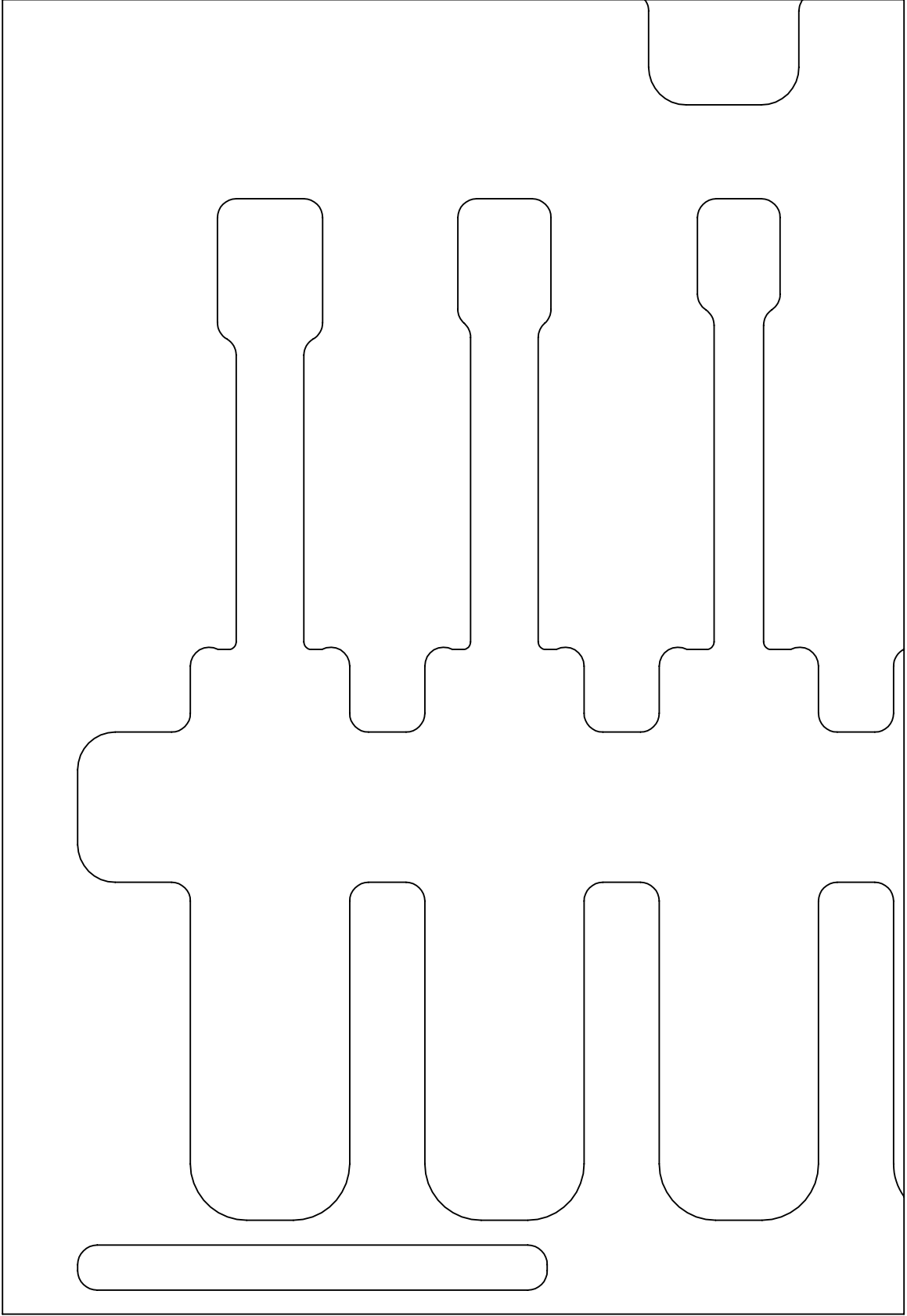

Print on Letter at 100%

PART NUMBER
F1M-00530

DATE CREATED
9 MAY 2013

1.00 IN

PAGE KEY

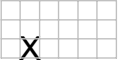

1.00
IN

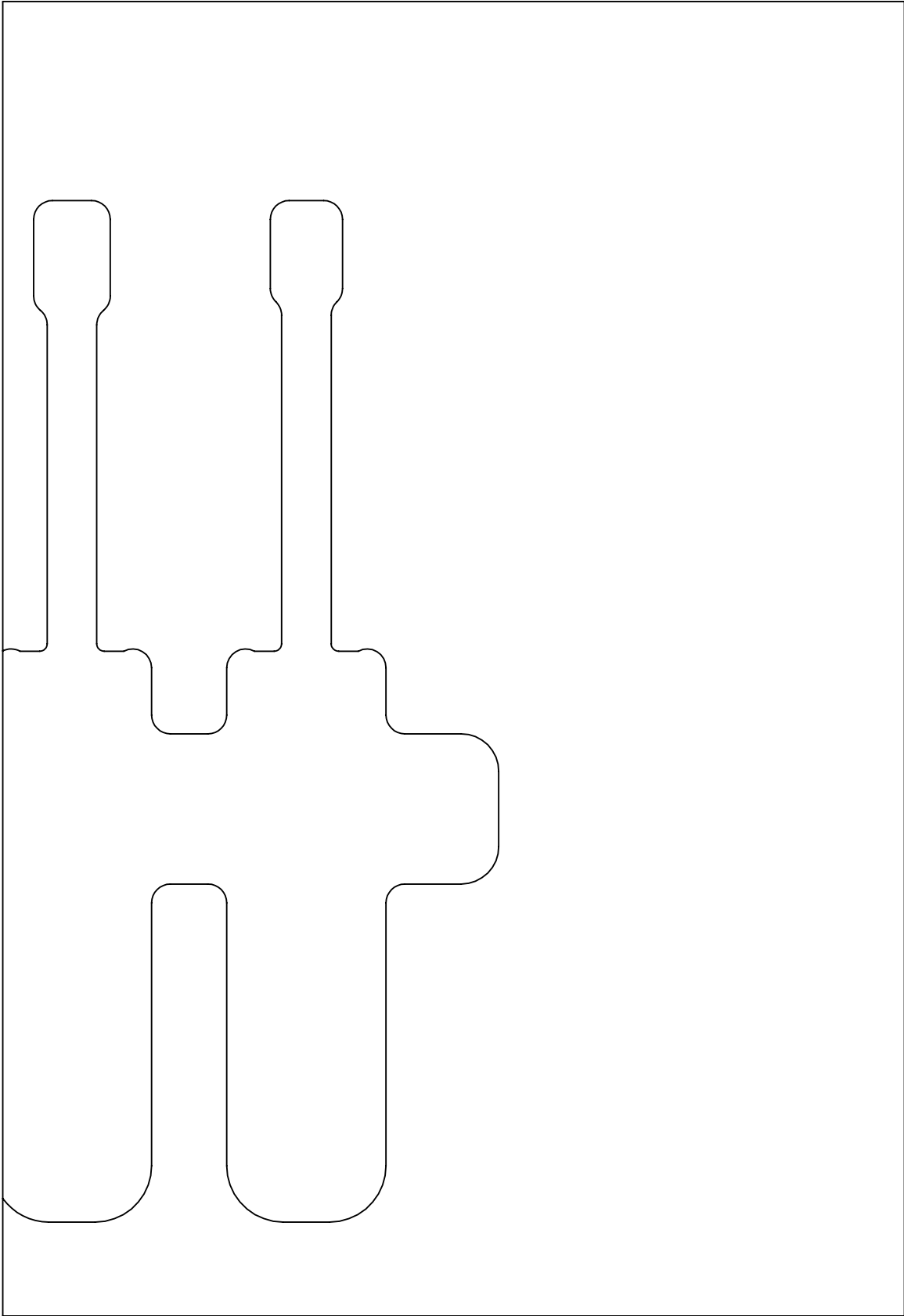

Print on Letter at 100%

DATE CREATED

9 MAY 2013

PART NUMBER

F1M-00530

1.00 IN

PAGE KEY



1.00
IN

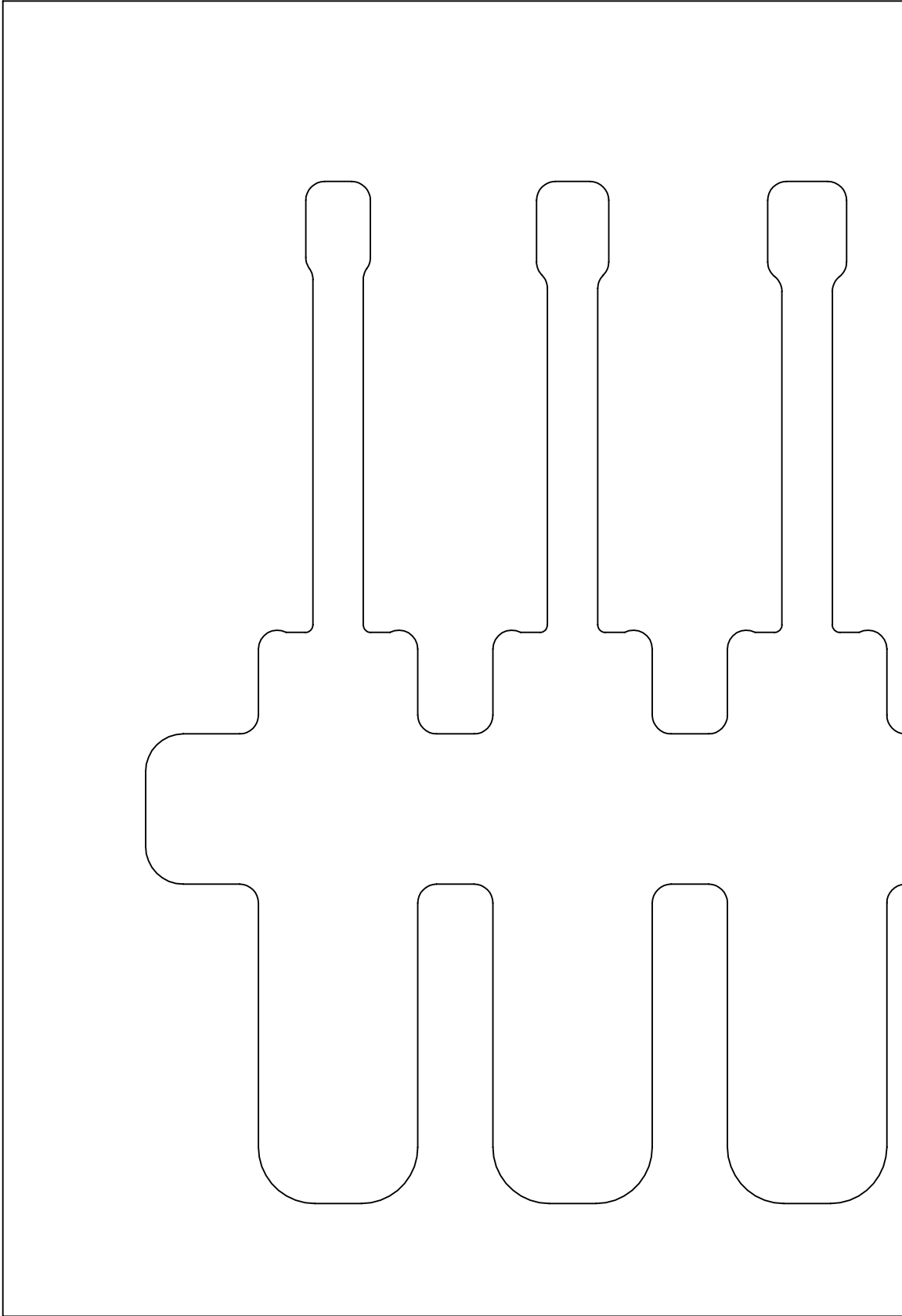

Print on Letter at 100%

DATE CREATED
9 MAY 2013

PART NUMBER
F1M-00530

Print on Letter at 100%

1.00 IN

1.00
IN

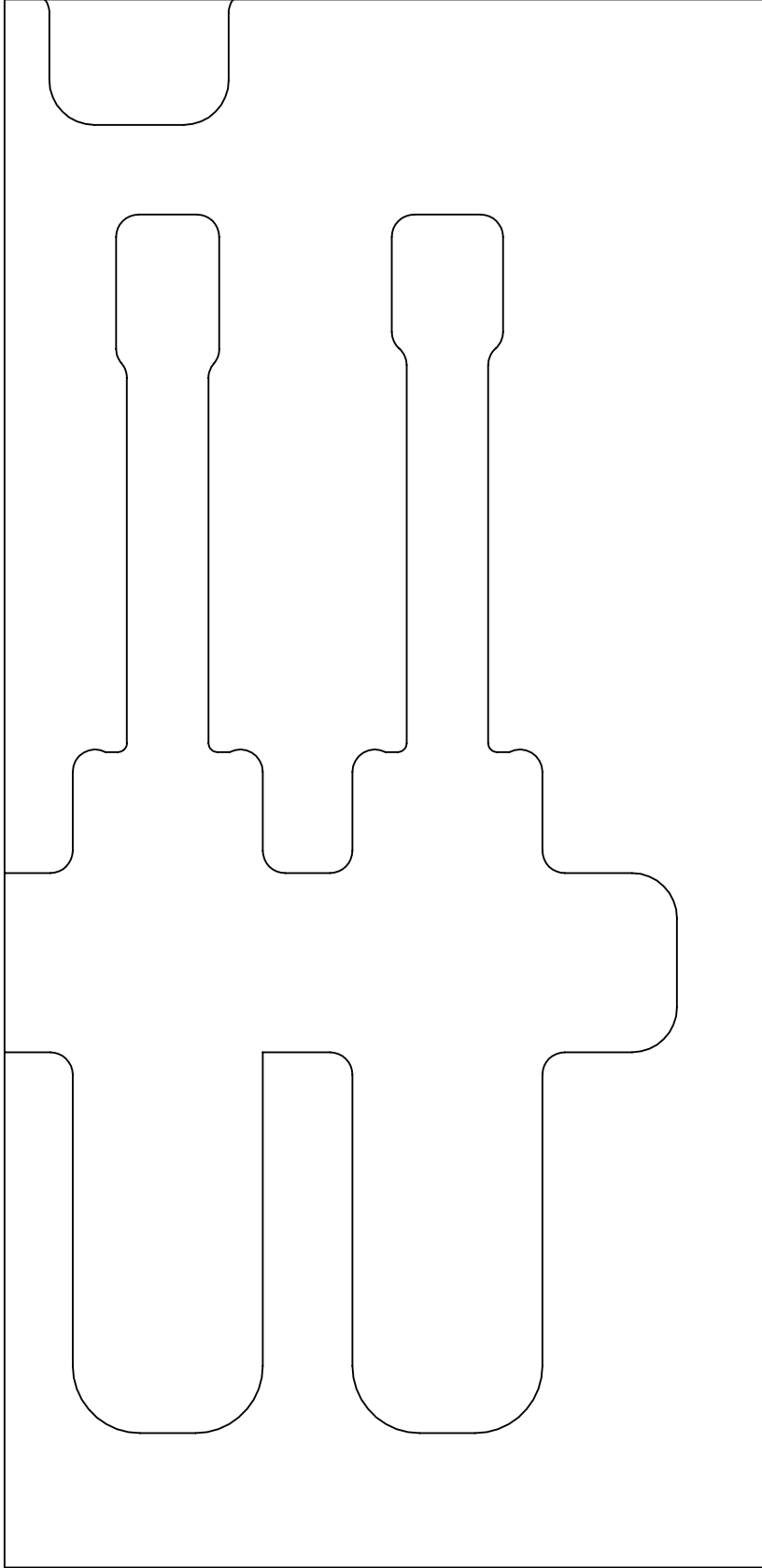

PAGE KEY



DATE CREATED
9 MAY 2013

PART NUMBER
F1M-00530

1.00 IN

PAGE KEY

X									
---	--	--	--	--	--	--	--	--	--

1.00
IN

Print on Letter at 100%

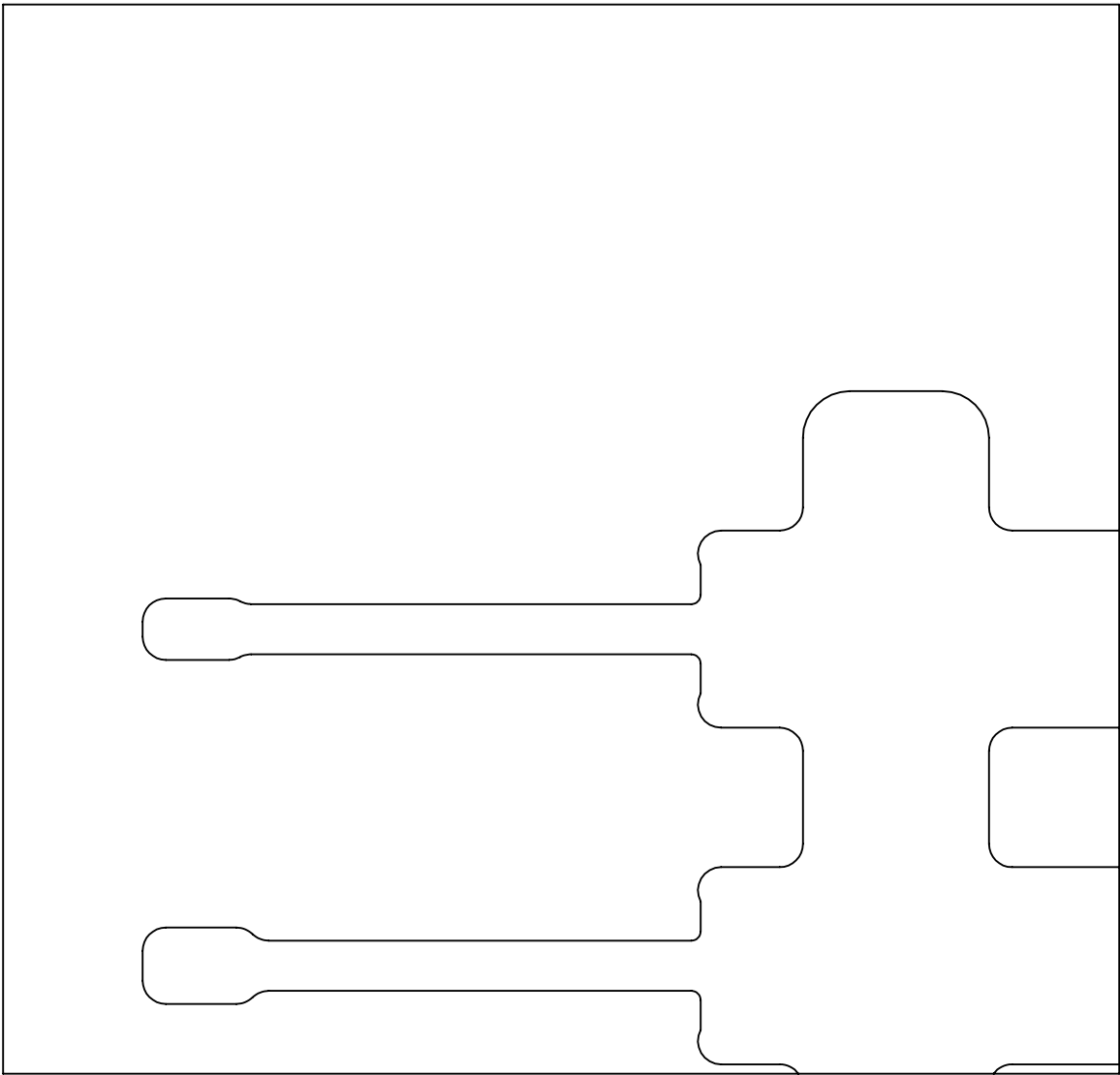

DATE CREATED

9 MAY 2013

PART NUMBER

F1M-00530

1.00 IN

PAGE KEY

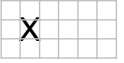

1.00
IN

Print on Letter at 100%

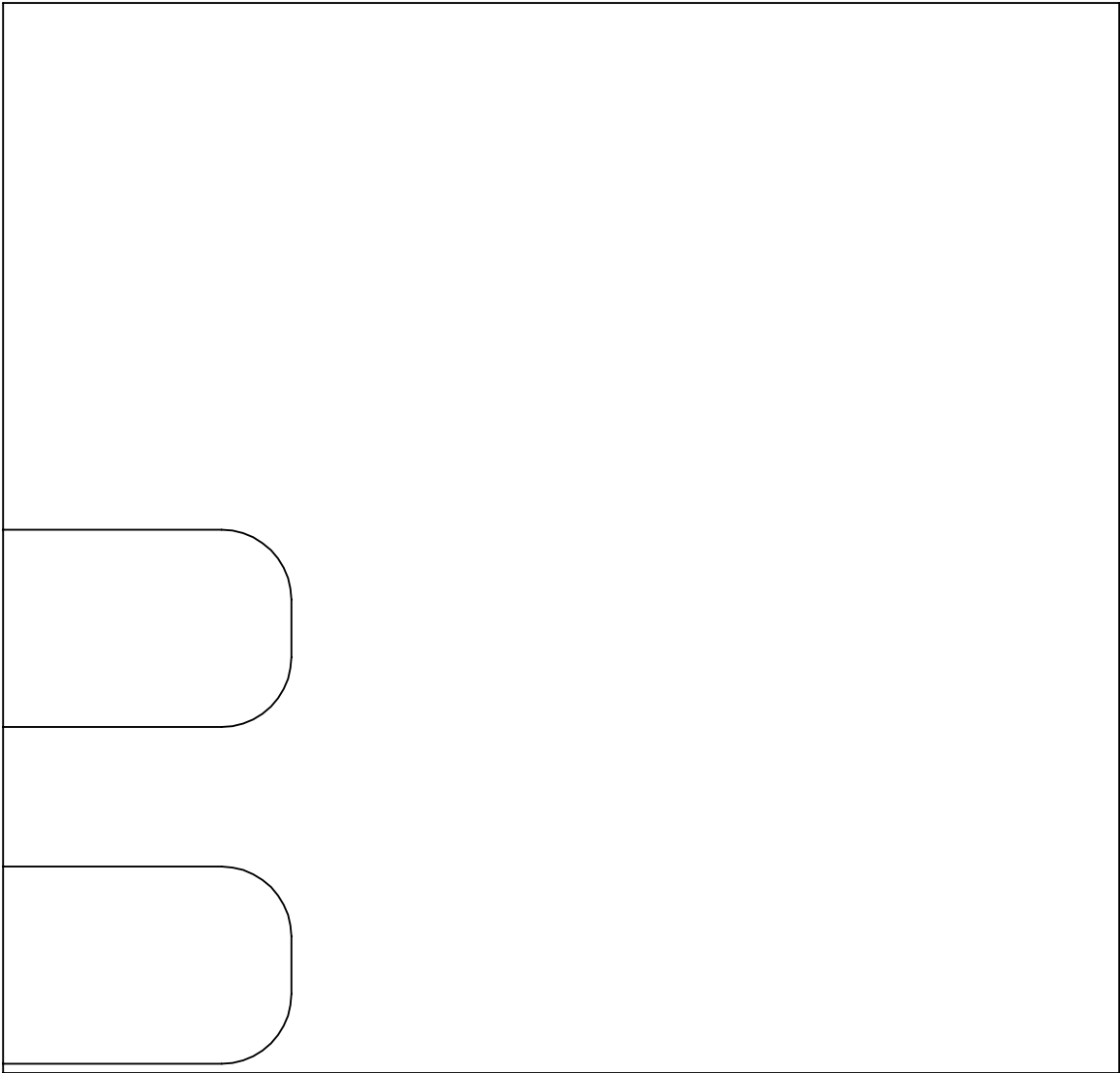

DATE CREATED

9 MAY 2013

PART NUMBER

F1M-00530



1.00 IN

PAGE KEY

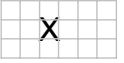

1.00
IN

Print on Letter at 100%

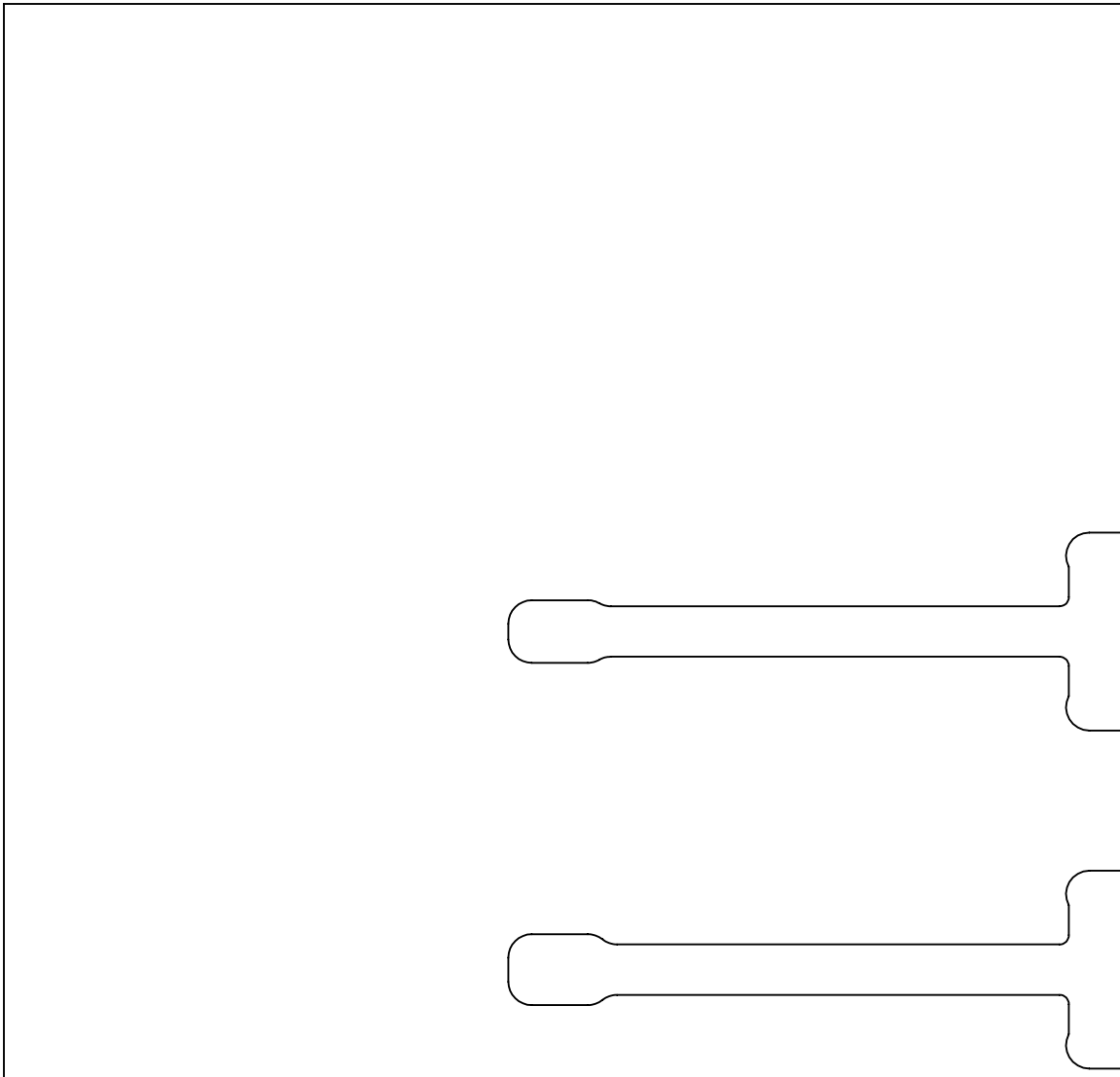

DATE CREATED

9 MAY 2013

PART NUMBER

F1M-00530



1.00 IN

PAGE KEY

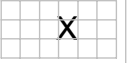

1.00
IN

Print on Letter at 100%

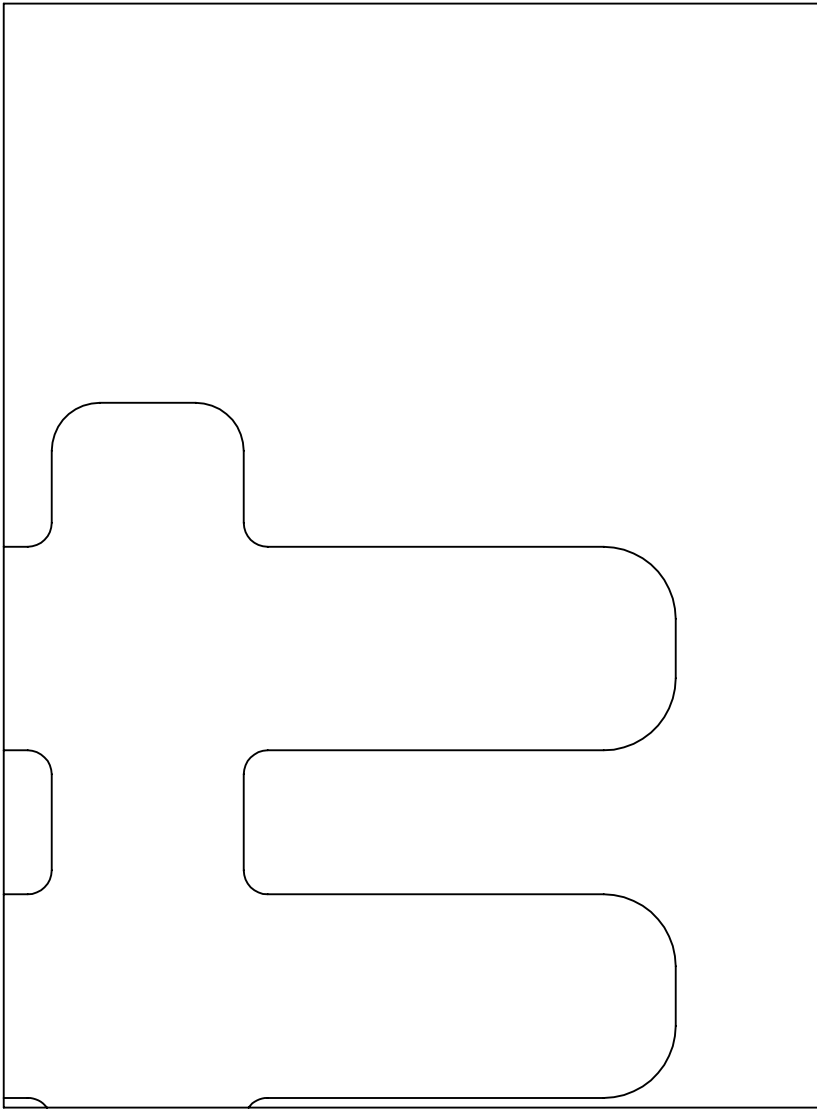

PART NUMBER	DATE CREATED
F1M-00530	9 MAY 2013