

**PRINTING INSTRUCTIONS**

Print at full-scale and place tools over the paper to verify the fit.

**Option 1:** Print this page full-scale on a large-format printer (E-Size, 44 inches X 34 inches).

**Option 2:** Print page 2 - 7 on 8-1/2 X 11 inch paper and assemble.

THE INFORMATION CONTAINED ON THIS DRAWING IS THE SOLE PROPERTY OF FOAMFIT TOOLS AND MAY NOT BE USED WITHOUT PERMISSION. Copyright 2026 FoamFit Tools

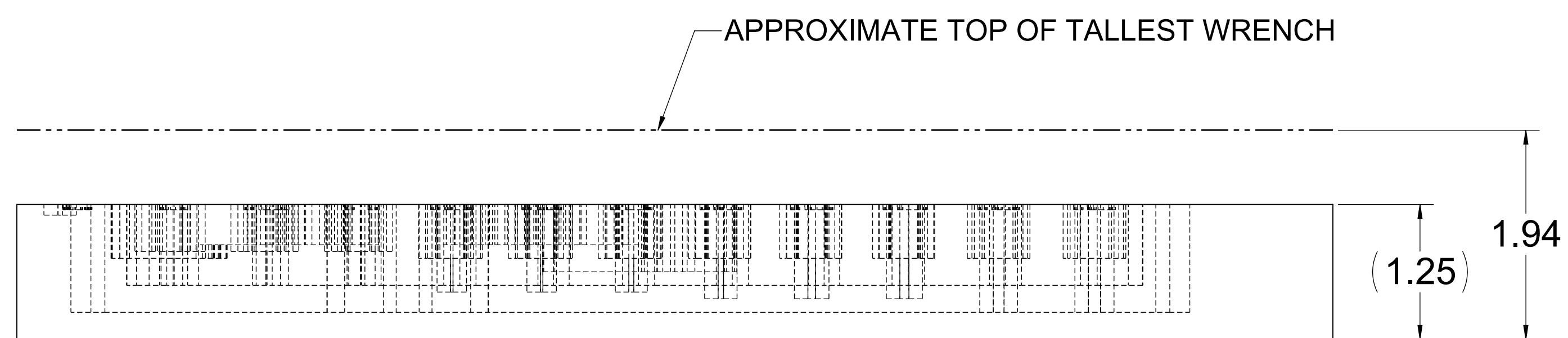
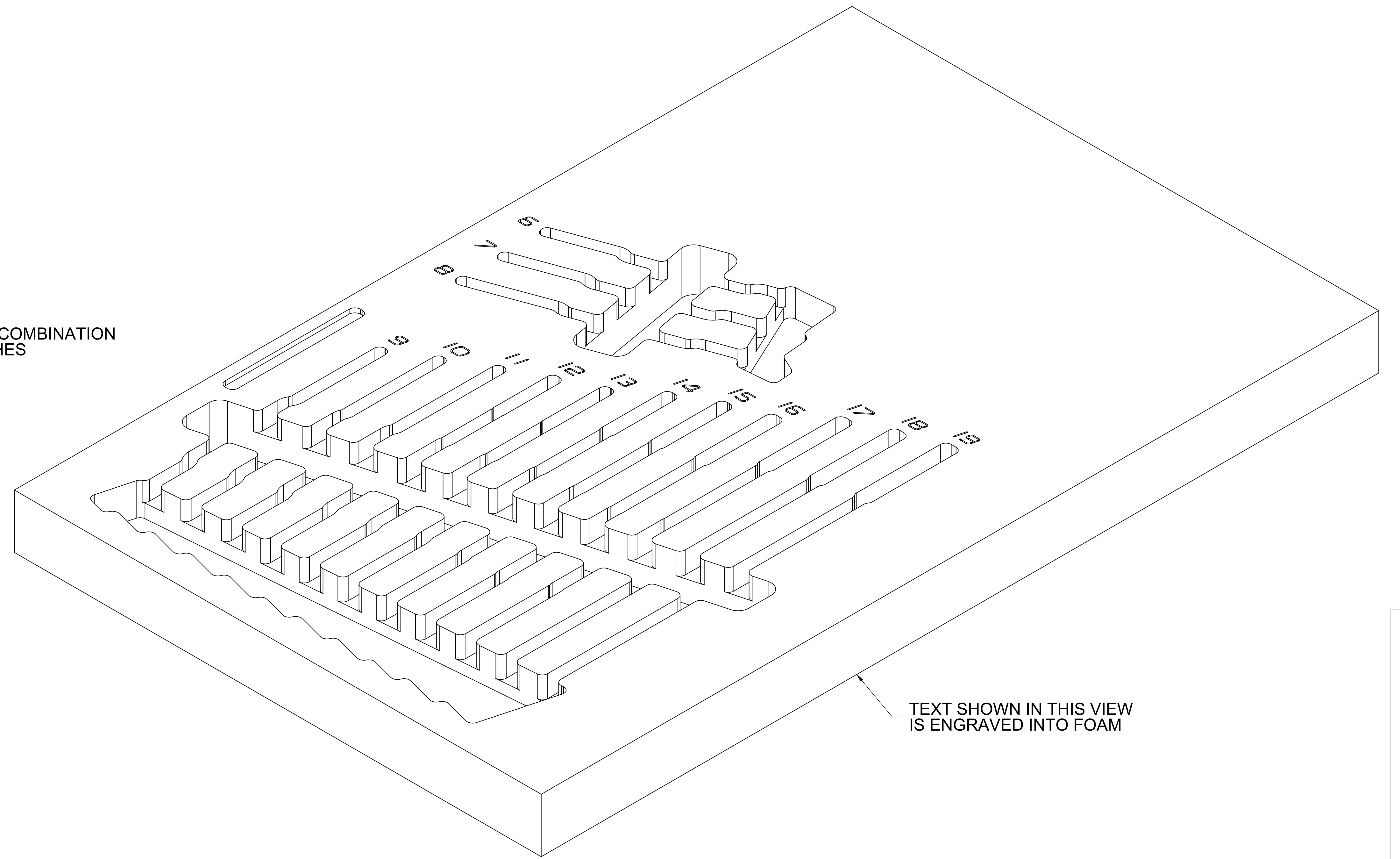
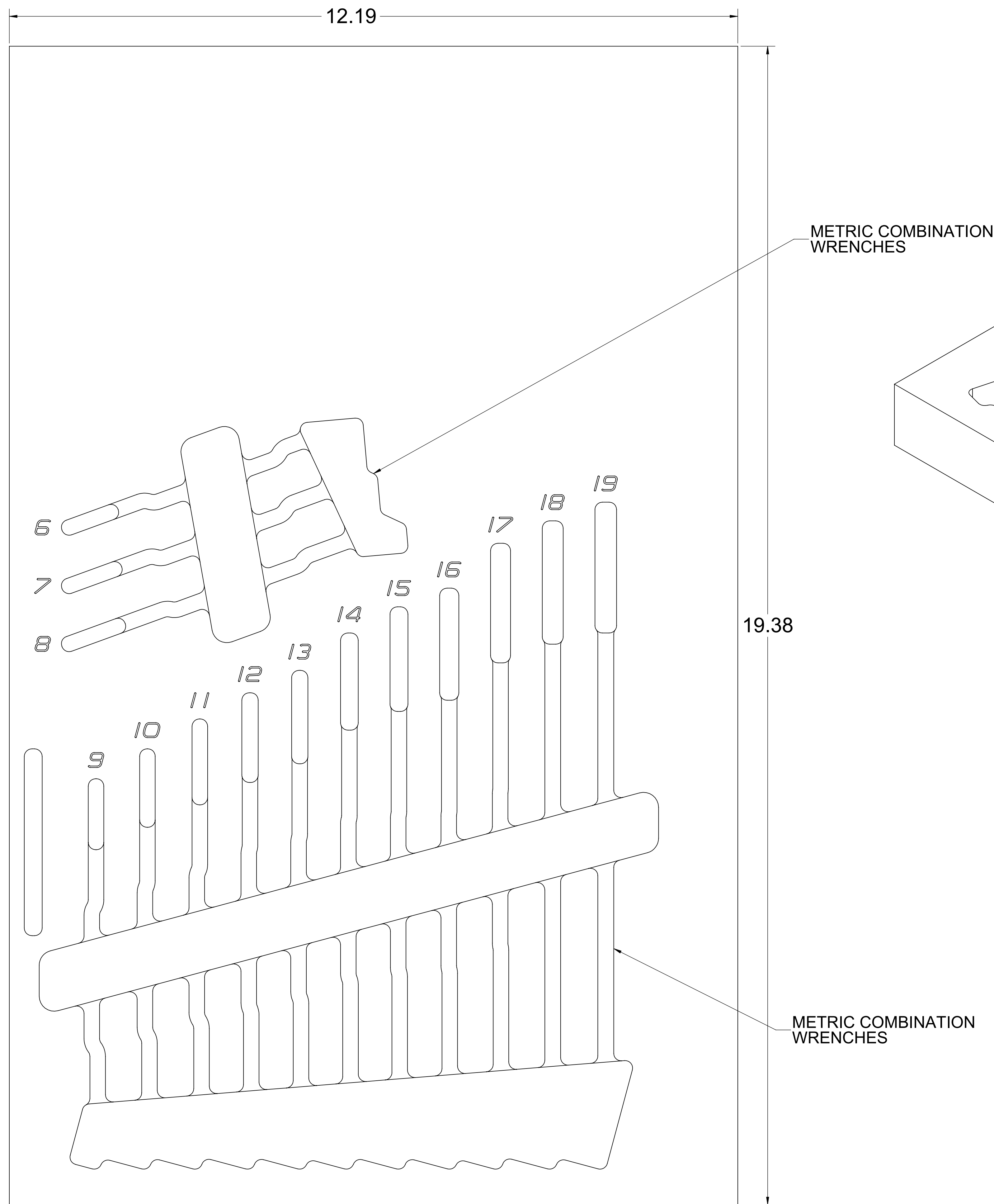

CAUTION  
SUGGESTED DRAWER HEIGHT  
2.19 MIN

PART NUMBER  
**L-06399-T**

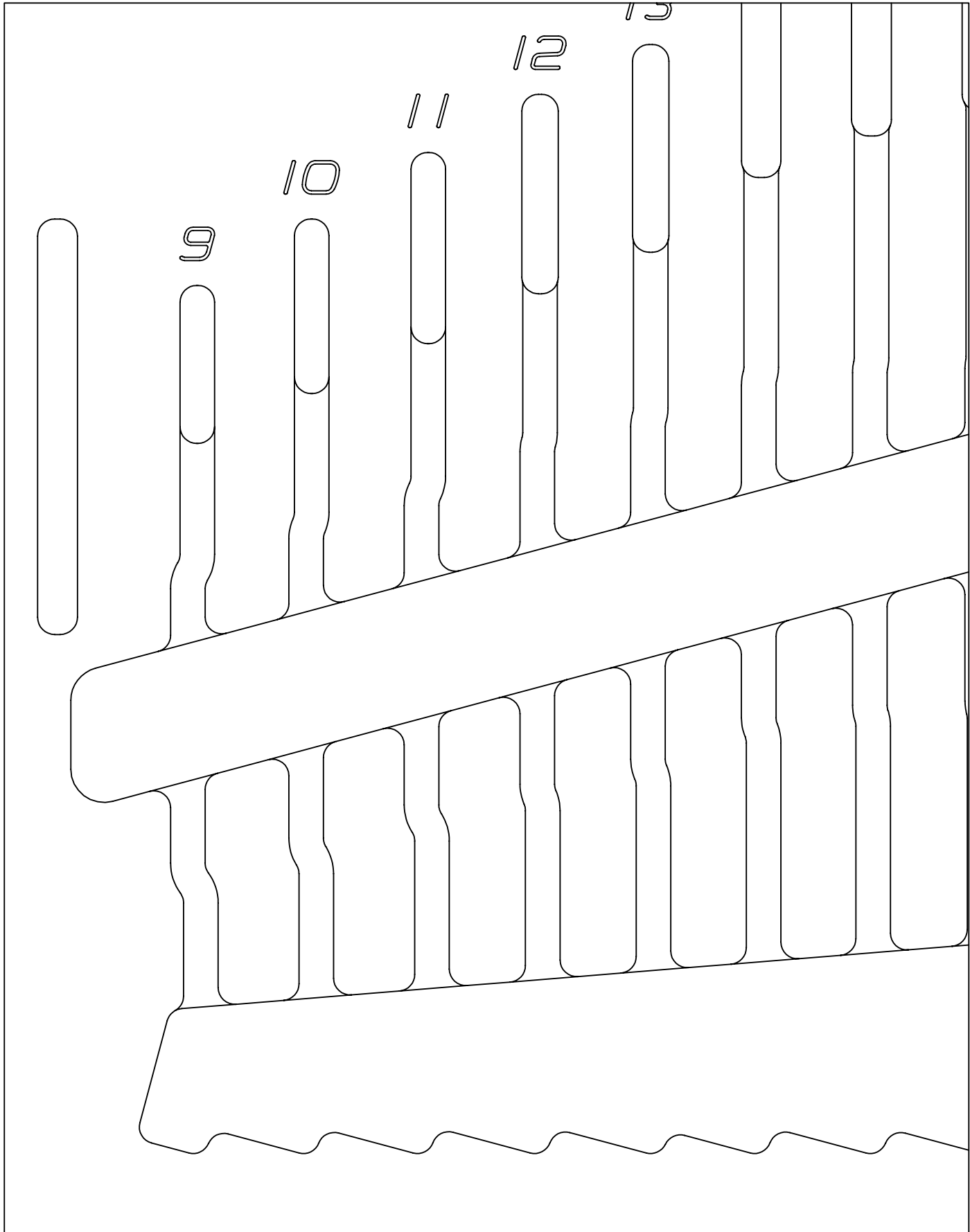

PART NUMBER

**L-06399-T**

PAGE (ROW-COLUMN)

**1-1**

Numbering starts  
from the front  
left corner.

DATE CREATED

13 MAR 2026

DATE REVISED

***FoamFit Tools***

Print on Letter at 100%

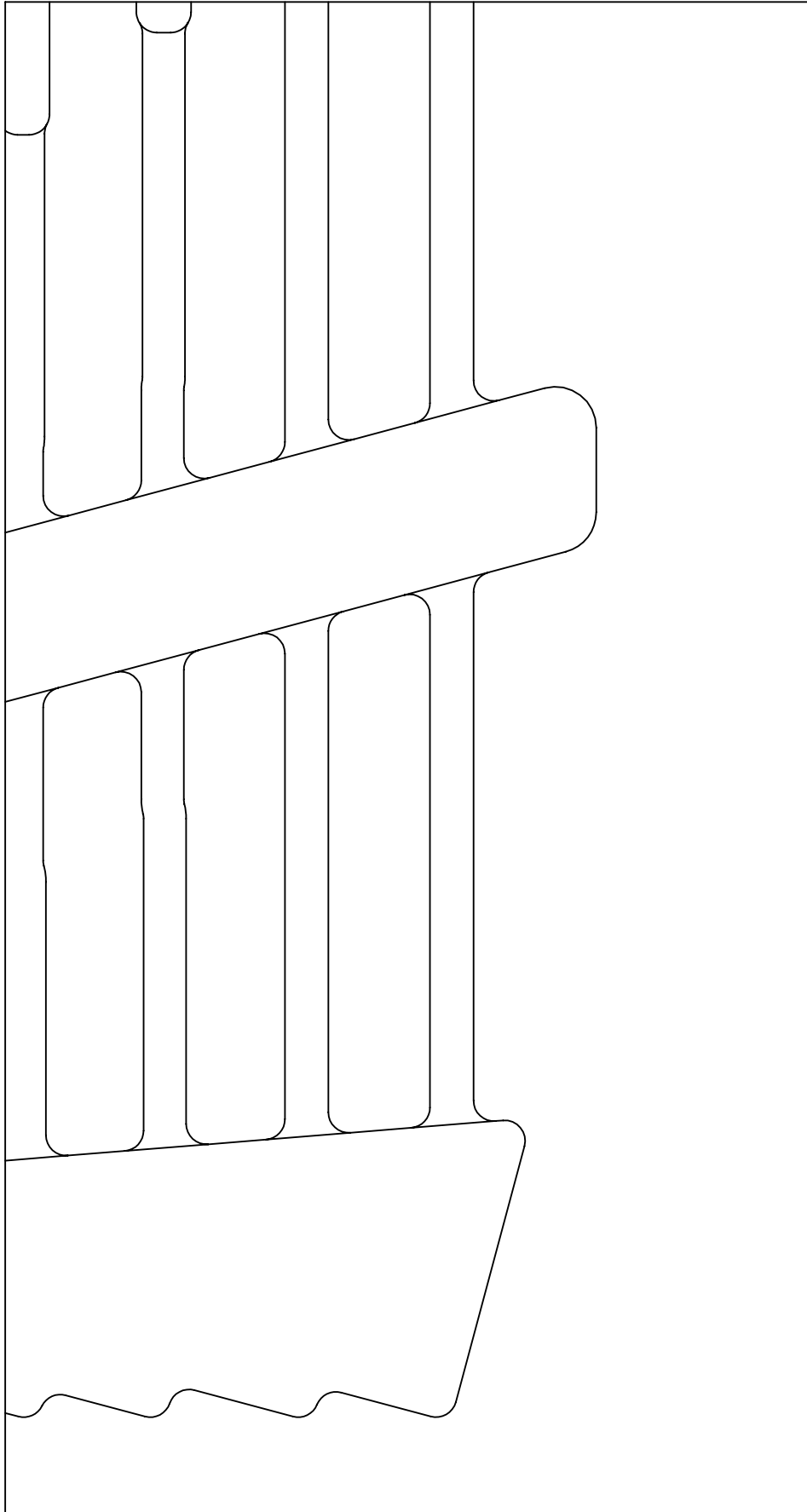

PART NUMBER

**L-06399-T**

PAGE (ROW-COLUMN)

**1-2**

Numbering starts  
from the front  
left corner.

DATE CREATED

13 MAR 2026

DATE REVISED

***FoamFit Tools***

Print on Letter at 100%

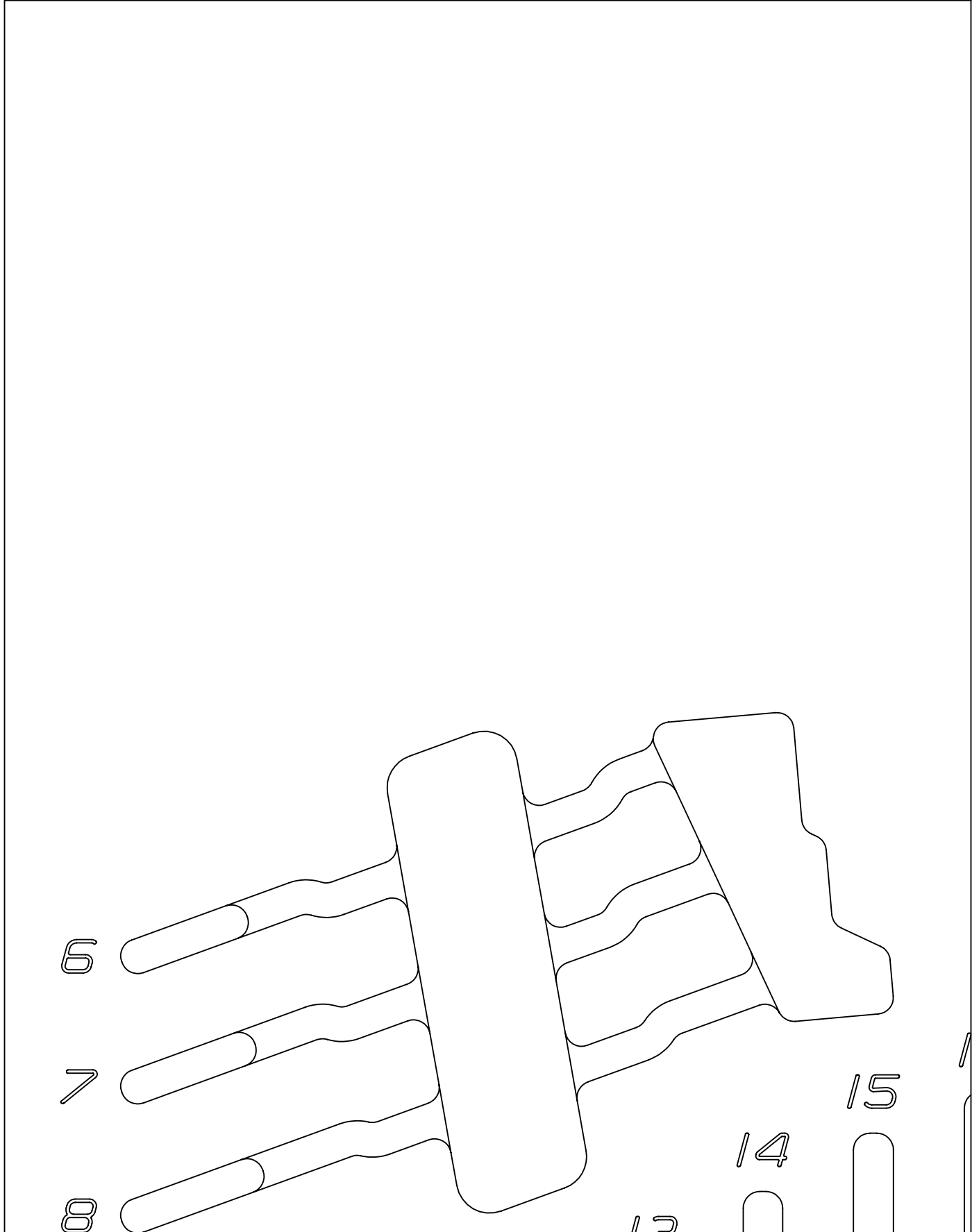

PART NUMBER

**L-06399-T**

PAGE (ROW-COLUMN)

**2-1**

Numbering starts  
from the front  
left corner.

DATE CREATED

13 MAR 2026

DATE REVISED

***FoamFit Tools***

Print on Letter at 100%

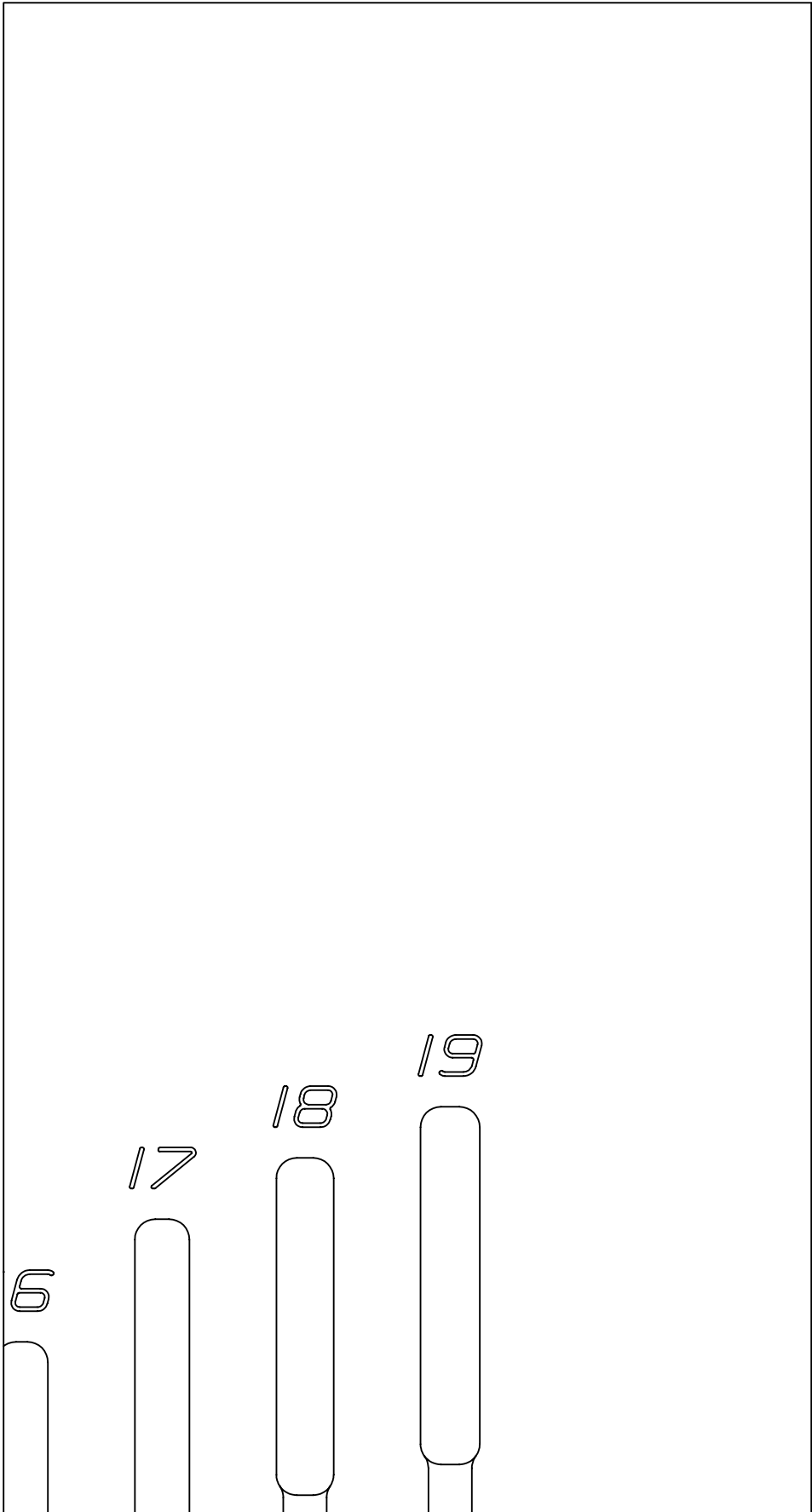

PART NUMBER

**L-06399-T**

PAGE (ROW-COLUMN)

**2-2**

Numbering starts  
from the front  
left corner.

DATE CREATED

13 MAR 2026

DATE REVISED

***FoamFit Tools***

Print on Letter at 100%



PART NUMBER

**L-06399-T**

PAGE (ROW-COLUMN)

**3-1**

Numbering starts  
from the front  
left corner.

DATE CREATED

13 MAR 2026

DATE REVISED

***FoamFit Tools***

Print on Letter at 100%



PART NUMBER <b>L-06399-T</b>	PAGE (ROW-COLUMN) <b>3-2</b> <small>Numbering starts from the front left corner.</small>	DATE CREATED <b>13 MAR 2026</b>	DATE REVISED	<b><i>FoamFit Tools</i></b> Print on Letter at 100%
---------------------------------	--	------------------------------------	--------------	--